



ASSOCIATION CONNECTING
ELECTRONICS INDUSTRIES

IPC-A-600G

Acceptability of Printed Boards

IPC-A-600G

July 2004

A standard developed by IPC

Supersedes IPC-A-600F
November 1999

2215 Sanders Road, Northbrook, IL 60062-6135
Tel. 847.509.9700 Fax 847.509.9798
www.ipc.org

The Principles of Standardization

In May 1995 the IPC's Technical Activities Executive Committee adopted Principles of Standardization as a guiding principle of IPC's standardization efforts.

Standards Should:

- Show relationship to Design for Manufacturability (DFM) and Design for the Environment (DFE)
- Minimize time to market
- Contain simple (simplified) language
- Just include spec information
- Focus on end product performance
- Include a feedback system on use and problems for future improvement

Standards Should Not:

- Inhibit innovation
- Increase time-to-market
- Keep people out
- Increase cycle time
- Tell you how to make something
- Contain anything that cannot be defended with data

Notice

IPC Standards and Publications are designed to serve the public interest through eliminating misunderstandings between manufacturers and purchasers, facilitating interchangeability and improvement of products, and assisting the purchaser in selecting and obtaining with minimum delay the proper product for his particular need. Existence of such Standards and Publications shall not in any respect preclude any member or nonmember of IPC from manufacturing or selling products not conforming to such Standards and Publication, nor shall the existence of such Standards and Publications preclude their voluntary use by those other than IPC members, whether the standard is to be used either domestically or internationally.

Recommended Standards and Publications are adopted by IPC without regard to whether their adoption may involve patents on articles, materials, or processes. By such action, IPC does not assume any liability to any patent owner, nor do they assume any obligation whatever to parties adopting the Recommended Standard or Publication. Users are also wholly responsible for protecting themselves against all claims of liabilities for patent infringement.

IPC Position Statement on Specification Revision Change

It is the position of IPC's Technical Activities Executive Committee (TAEC) that the use and implementation of IPC publications is voluntary and is part of a relationship entered into by customer and supplier. When an IPC publication is updated and a new revision is published, it is the opinion of the TAEC that the use of the new revision as part of an existing relationship is not automatic unless required by the contract. The TAEC recommends the use of the latest revision.
Adopted October 6, 1998

Why is there a charge for this document?

Your purchase of this document contributes to the ongoing development of new and updated industry standards and publications. Standards allow manufacturers, customers, and suppliers to understand one another better. Standards allow manufacturers greater efficiencies when they can set up their processes to meet industry standards, allowing them to offer their customers lower costs.

IPC spends hundreds of thousands of dollars annually to support IPC's volunteers in the standards and publications development process. There are many rounds of drafts sent out for review and the committees spend hundreds of hours in review and development. IPC's staff attends and participates in committee activities, typesets and circulates document drafts, and follows all necessary procedures to qualify for ANSI approval.

IPC's membership dues have been kept low to allow as many companies as possible to participate. Therefore, the standards and publications revenue is necessary to complement dues revenue. The price schedule offers a 50% discount to IPC members. If your company buys IPC standards and publications, why not take advantage of this and the many other benefits of IPC membership as well? For more information on membership in IPC, please visit www.ipc.org or call 847/790-5372.

Thank you for your continued support.



ASSOCIATION CONNECTING
ELECTRONICS INDUSTRIES

IPC-A-600G

Acceptability of Printed Boards

Developed by the IPC-A-600 Task Group (7-31a) of the Product Assurance Committee (7-30) of IPC

Supersedes:

IPC-A-600F - November 1999

Users of this publication are encouraged to participate in the development of future revisions.

Contact:

IPC
2215 Sanders Road
Northbrook, Illinois
60062-6135
Tel 847 509.9700
Fax 847 509.9798

Acknowledgement

Any standard involving a complex technology draws material from a vast number of sources. While the principal members of the A-600 Task Group (7-31a) of the Product Assurance Committee (7-30) are shown below, it is not possible to include all of those who assisted in the evolution of this standard. To each of them, the members of IPC extend their gratitude. who assisted in the evolution of this standard. To each of them, the members of IPC extend their gratitude. Special thanks goes to the members of the D-30 Rigid Printed Board Committee for their efforts in establishing acceptance criteria for printed boards.

Product Assurance Committee	IPC-A-600 Task Group	IPC Rigid Printed Board Committee
Chair	Chair	Chair
Mel Parrish	Mark Buechner	C. Don Dupriest
Soldering Technology International	BAE Systems	Lockheed Martin Missiles & Fire Control

Technical Liaisons of the
IPC Board of Directors

Peter Bigelow
IMI Inc.

Sammy Yi
Flextronics International

<p>Mary E. Bellon, Boeing Satellite Systems Gerald Leslie Bogert, Bechtel Plant Machinery, Inc. Scott A. Bowles, Sovereign Circuits Inc. Ronald J. Brock, NSWC - Crane Dennis J. Cantwell, Printed Circuits Inc. Byron Case, L-3 Communications Pei-Liang Chen, Shanghai Printronics Circuit Phillip Chen, Northrop Grumman Canada Corporation Christine R. Coapman, Delphi Delco Electronics Systems W. Glenn Colescott, Delphi Delco Electronics Systems Dan Colvin, Tyco PCG/Logan Division Christopher Conklin, Lockheed Martin Corporation David J. Corbett, Defense Supply Center Columbus Dennis DeBord, Nortel Networks Center 1 C. Don Dupriest, Lockheed Martin Missiles & Fire Control Theodore Edwards, Dynaco Corp. Werner Engelmaier, Engelmaier Associates, L.C. Gary M. Ferrari, C.I.D.+, Ferrari Technical Services Lionel Fullwood, WKK Distribution Ltd. Mahendra S. Gandhi, Northrop Grumman Thomas F. Gardeski, E. I. du Pont de Nemours and Co. Floyd L. Gentry, Sandia National Labs Albuquerque Constantino J. Gonzalez, ACME Training & Consulting</p>	<p>Robert J. Gordon, Visteon Corp. Hue T. Green, Lockheed Martin Space Systems Company Ken Greene, Siemens Energy and Automation Michael R. Green, Lockheed Martin Space Systems Company Samy Hanna, AT&S Austria Technologie & Systemtechnik Michael E. Hill, Colonial Circuits Phillip E. Hinton, Hinton 'PWB' Engineering Kazuo Hirasaka, Eastern Manufacturing Ted J. Jones, NSWC - Crane Thomas E. Kemp, Rockwell Collins Arshad Khan, Celestica International Inc. Clarence W. Knapp, Litton Systems Inc. Jason Koch, Robisan Laboratory Inc. Raymond L. Kolonchuk, Jr., Defense Supply Center Columbus Nick Koop, Minco Products Inc. Leo P. Lambert, EPTAC Corporation Michael G. Luke, C.I.D., Raytheon Company Chris Mahanna, Robisan Laboratory Inc. Wesley R. Malewicz, Draeger Medical Systems, Inc. Susan S. Mansilla, Robisan Laboratory Inc. Rene R. Martinez, Northrop Grumman Brian C. McCrory, Delsen Testing Laboratories Ronald McInay, Medtronic Physio-Control Randy McNutt, Northrop Grumman Renee J. Michalkiewicz, Trace Laboratories - East</p>	<p>James H. Moffitt, Moffitt Consulting Services Bob Neves, Microtek Laboratories Benny Nilsson, Ericsson AB Debora L. Obitz, Trace Laboratories - East William Ortloff, B/C Engineering Donald G. Pucci, Gould Electronics Inc. Jim R. Reed, Dell Computer Corporation Randy R. Reed, Merix Corporation Gary C. Roper, Eagle Circuits Inc. Visa Ruuhonen, Nokia Networks Russell S. Shepherd, Microtek Laboratories Lowell Sherman, Defense Supply Center Columbus Akikazu Shibata, Ph.D., JPCA-Japan Printed Circuit Association Hans L. Shin, Pacific Testing Laboratories, Inc. Frank A. Stetson, Training & Certification Specialists Roger Su, L-3 Communications Gail Tennant, Celestica Ronald E. Thompson, NSWC - Crane Dung Q. Tiet, Lockheed Martin Space Systems Company Robert Vanech Rob Walls, C.I.D.+, PIEK International Education Centre BV Ronnie Walker, Northrop Grumman Clark F. Webster, ALL Flex Inc. Robert B. Whitehouse, Sanmina-SCI Corporation Philip W. Wittmer, Delphi Delco Electronics Systems</p>
---	--	---

PWB on front and back cover photo courtesy of U.S. Robotics

Table of Contents

Acknowledgement	i	2.7 Printed Contacts	29
1.0 Introduction	1	2.7.1 Surface Plating - General	29
1.1 Scope	1	2.7.1.1 Surface Plating - Wire Bond Pads ...	30
1.2 Purpose	1	2.7.2 Burrs on Edge-Board Contacts	31
1.3 Approach To This Document	1	2.7.3 Adhesion of Overplate	32
1.4 Classification	1	2.8 Marking	33
1.5 Acceptance Criteria	2	2.8.1 Etched Marking	34
1.6 Applicable Documents	3	2.8.2 Screened or Ink Stamped Marking	35
1.7 Dimensions And Tolerances	3	2.9 Solder Resist (Solder Mask)	36
1.8 Terms And Definitions	3	2.9.1 Coverage Over Conductors (Skip Coverage)	37
1.9 Workmanship	3	2.9.2 Registration to Holes (All Finishes) ...	38
2.0 Externally Observable Characteristics	4	2.9.3 Registration to Other Conductive Patterns	39
2.1 Board Edges	4	2.9.3.1 Ball Grid Array (Solder Resist- Defined Lands)	40
2.1.1 Burrs	4	2.9.3.2 Ball Grid Array (Copper-Defined Lands)	41
2.1.1.1 Nonmetallic Burrs	5	2.9.3.3 Ball Grid Array (Solder Dam)	42
2.1.1.2 Metallic Burrs	6	2.9.4 Blisters/Delamination	43
2.1.2 Nicks	7	2.9.5 Adhesion (Flaking or Peeling)	44
2.1.3 Haloing	8	2.9.6 Waves/Wrinkles/Ripples	45
2.2 Base Material	9	2.9.7 Tenting (Via Holes)	46
2.2.1 Weave Exposure	10	2.9.8 Soda Strawing	47
2.2.2 Weave Texture	11	2.10 Pattern Definition - Dimensional	48
2.2.3 Exposed/Disrupted Fibers	12	2.10.1 Conductor Width and Spacing	48
2.2.4 Pits and Voids	13	2.10.1.1 Conductor Width	49
2.3 Base Material Subsurface	14	2.10.1.2 Conductor Spacing	50
2.3.1 Measling	17	2.10.2 External Annular Ring - Measurement	51
2.3.2 Crazeing	18	2.10.3 External Annular Ring - Supported Holes	52
2.3.3 Delamination/Blister	19	2.10.4 External Annular Ring - Unsupported Holes	53
2.3.4 Foreign Inclusions	20	2.11 Flatness	54
2.4 Solder Coatings and Fused Tin Lead	21	3.0 Internally Observable Characteristics	55
2.4.1 Nonwetting	21	3.1 Dielectric Materials	56
2.4.2 Dewetting	22	3.1.1 Laminate Voids (Outside Thermal Zone)	56
2.5 Holes – Plated-Through – General	23	3.1.2 Registration/Conductors to Holes ...	58
2.5.1 Nodules/Burrs	23	3.1.3 Clearance Hole, Unsupported, to Power/Ground Planes	59
2.5.2 Pink Ring	24	3.1.4 Delamination/Blister	60
2.5.3 Voids - Copper Plating	25	3.1.5 Etchback	61
2.5.4 Voids - Finished Coating	26		
2.5.5 Lifted Lands - (Visual)	27		
2.6 Holes – Unsupported	28		
2.6.1 Haloing	28		

Table of Contents

<ul style="list-style-type: none"> 3.1.5.1 Etchback 62 3.1.5.2 Negative Etchback 63 3.1.6 Smear Removal 64 3.1.7 Dielectric Material, Clearance, Metal Plane for Supported Holes 65 3.1.8 Layer-to-Layer Spacing 66 3.1.9 Resin Recession 67 3.2 Conductive Patterns - General 68 <ul style="list-style-type: none"> 3.2.1 Etching Characteristics 69 3.2.2 Print and Etch 71 3.2.3 Surface Conductor Thickness (Foil Plus Plating) 72 3.2.4 Foil Thickness - Internal Layers 72 3.3 Plated-Through Holes - General 73 <ul style="list-style-type: none"> 3.3.1 Annular Ring - Internal Layers 75 3.3.2 Lifted Lands - (Cross-Sections) 77 3.3.3 Foil Crack - (Internal Foil) "C" Crack 78 3.3.4 Foil Crack - (External Foil) 79 3.3.5 Plating Crack - (Barrel) "E" Crack 80 3.3.6 Plating Crack - (Corner) "F" Crack 81 3.3.7 Plating Nodules 82 3.3.8 Copper Plating Thickness - Hole Wall 83 3.3.9 Plating Voids 84 3.3.10 Solder Coating Thickness (Only When Specified) 85 3.3.11 Solder Resist Thickness 86 3.3.12 Wicking 87 3.3.12.1 Wicking, Clearance Holes 88 3.3.13 Innerlayer Separation - Vertical (Axial) Microsection 89 3.3.14 Innerlayer Separation - Horizontal (Transverse) Microsection 90 3.3.15 Material Fill of Blind and Buried Vias 91 3.4 Plated-Through Holes - Drilled 92 <ul style="list-style-type: none"> 3.4.1 Burrs 93 3.4.2 Nailheading 94 3.5 Plated-Through Holes - Punched 95 <ul style="list-style-type: none"> 3.5.1 Roughness and Nodules 96 3.5.2 Flare 97 4.0 Miscellaneous 98 	<ul style="list-style-type: none"> 4.1 Flexible And Rigid-Flex Printed Wiring 98 <ul style="list-style-type: none"> 4.1.1 Coverlayer Coverage - Coverfilm Separations 99 4.1.2 Coverlayer/Cover Coat Coverage Adhesives 100 <ul style="list-style-type: none"> 4.1.2.1 Adhesive Squeeze-Out - Land Area 100 4.1.2.2 Adhesive Squeeze-Out - Foil Surface 101 4.1.3 Access Hole Registration for Coverlayer and Stiffeners 102 4.1.4 Plating Defects 103 4.1.5 Stiffener Bonding 104 4.1.6 Transition Zone, Rigid Area to Flexible Area 105 4.1.7 Solder Wicking/Plating Migration Under Coverlayer 106 4.1.8 Laminate Integrity 107 <ul style="list-style-type: none"> 4.1.8.1 Laminate Integrity - Flexible Printed Wiring 108 4.1.8.2 Laminate Integrity - Rigid-Flex Printed Wiring 109 4.1.9 Etchback (Type 3 and Type 4 Only) 110 4.1.10 Smear Removal (Type 3 and 4 Only) 111 4.1.11 Trimmed Edges/Edge Delamination 112 4.2 Metal Core Printed Boards 113 <ul style="list-style-type: none"> 4.2.1 Type Classifications 114 4.2.2 Spacing Laminated Type 115 4.2.3 Insulation Thickness, Insulated Metal Substrate 116 4.2.4 Insulation Material Fill, Laminated Type Metal Core 117 4.2.5 Cracks in Insulation Material Fill, Laminated Type 118 4.2.6 Core Bond to Plated-Through Hole Wall 119 4.3 Flush Printed Boards 120 <ul style="list-style-type: none"> 4.3.1 Flushness of Surface Conductor ... 120 5.0 Cleanliness Testing 121 5.1 Solderability Testing 122 <ul style="list-style-type: none"> 5.1.1 Plated-Through Holes 123 5.2 Electrical Integrity 124
---	--

1.0 INTRODUCTION

Introduction

1.1 SCOPE

This document describes the preferred, acceptable, and non-conforming conditions that are either externally or internally observable on printed boards. It represents the visual interpretation of minimum requirements set forth in various printed board specifications, i.e.; IPC-6010 series, ANSI/J-STD-003, etc.

1.2 PURPOSE

The visual illustrations in this document portray specific criteria of the requirements of current IPC specifications. In order to properly apply and use the content of this document, the printed wiring product should comply with the design requirements of the applicable IPC-2220 series document and the performance requirements of the applicable IPC-6010 series document. In the event the printed wiring product does not comply with these or equivalent requirements, then the acceptance criteria should be as defined between a user and supplier agreement as part of the procurement documentation.

The illustrations in this document portray specific criteria relating to the heading and subheading of each page, with brief descriptions of the acceptable and nonconforming conditions for each product class. (See 1.4 Classification.) The visual quality acceptance criteria are intended to provide proper tools for the evaluation of visual anomalies. The illustrations and photographs in each situation are related to specific requirements. The characteristics addressed are those that can be evaluated by visual observation and/or measurement of visually observable features.

Supported by appropriate user requirements, this document should provide effective visual criteria to quality assurance and manufacturing personnel.

This document cannot cover all of the reliability concerns encountered in the printed board industry; therefore, attributes not addressed in this issue **shall** be agreed upon between user and supplier. The value of this document lies in its use as a baseline document that may be modified by expansions, exceptions, and variations which may be appropriate for specific applications.

This is a document for minimum acceptability requirements and is not intended to be used as a performance specification for printed board manufacture or procurement.

In the event of a conflict between the requirements of this document and the applicable product performance specification, the following precedence **shall** be used:

- a) Approved Printed Board Procurement Document
- b) Generic Specifications

c) Applicable Performance Specification

d) Acceptability of Printed Boards (IPC-A-600)

When making accept and/or reject decisions, the awareness of documentation precedence must be maintained.

This document is a tool for observing how a product may deviate due to variation in processes. Refer to IPC-9191.

IPC-A-600 provides a useful tool for understanding and interpreting Automated Inspection Technology (AIT) results. AIT may be applicable to the evaluation of many of the dimensional characteristics illustrated in this document.

1.3 APPROACH TO THIS DOCUMENT

Characteristics are divided into two general groups:

- Externally Observable (Section 2)
- Internally Observable (Section 3)

“Externally observable” conditions are those features or imperfections which can be seen and evaluated on or from the exterior surface of the board. In some cases, such as voids or blisters, the actual condition is an internal phenomenon and is detectable from the exterior.

“Internally observable” conditions are those features or imperfections that require microsectioning of the specimen or other forms of conditioning for detection and evaluation. In some cases, these features may be visible from the exterior and require microsectioning in order to assess acceptability requirements.

Specimens should be illuminated during evaluation to the extent needed for effective examination. The illumination should be such that no shadow falls on the area of interest except those shadows caused by the specimen itself. It is recommended that polarization and/or dark field illumination be employed to prevent glare during the examination of highly reflective materials.

1.4 CLASSIFICATION

This document recognizes that the acceptable extent of imperfection for specific characteristics of printed boards may be determined by the intended end use. For this reason, three general classes have been established based on functional reliability and performance requirements.

Class 1 — General Electronic products: Includes consumer products, some computer and computer peripherals suitable for applications where cosmetic imperfections are not important, and the major requirement is function of the completed printed board.

Class 2 — Dedicated Service Electronic Products: Includes communications equipment, sophisticated business machines, and instruments where high performance and

1.0 INTRODUCTION

Introduction (cont.)

extended life is required, and for which uninterrupted service is desired, but is not critical. Certain cosmetic imperfections are allowed.

Class 3 — High Reliability Electronics Products: Includes equipment and products where continued performance or performance on demand is critical. Equipment downtime cannot be tolerated, and the equipment must function when required, such as life support systems or flight control systems. Printed boards in this class are suitable for applications where high levels of assurance are required and service is essential.

Acceptability criteria in this document have been separated so that printed board product may be evaluated to any one of the three classes. The use of one class for a specific characteristic does not mean that all other characteristics must meet the same class. Selection should be based on minimum need. The customer has the ultimate responsibility for identifying the class to which the product is evaluated. Thus, accept and/or reject decisions must be based on applicable documentation such as contracts, procurement documentation, specifications, standards and reference documents.

Requirement exceptions commonly used for industry segments such as Space and Military Avionics are described within Performance Specification Sheets in IPC-6012 and are designated as Class 3/A, Class 3/B, etc. The scope of IPC-A-600 does not include illustrations for these requirement exceptions and the user is encouraged to substitute text in IPC-A-600 with the requirements for these Performance Specification Sheets where applicable based on the corresponding subsection in IPC-6012.

1.5 ACCEPTANCE CRITERIA

Most of the illustrations and photographs included in this document represent three levels of quality for each specific characteristic; i.e., Target Condition, Acceptable and Nonconforming. The text included with each level establishes the "Acceptance Criteria" for each class of product.

Target Condition depicts the desired condition. This condition may not be necessary to ensure the reliability of the board in its service environment.

Acceptable indicates that the condition depicted, while not necessarily perfect, will maintain the integrity and reliability of the board in its service environment. The acceptable condition is considered acceptable for at least one or more classes but may not be acceptable for all classes, as specified by the associated acceptance criteria.

Nonconforming indicates that the condition depicted may be insufficient to ensure the reliability of the board in its service environment. The nonconforming condition is considered

unacceptable for at least one or more classes of product but may be acceptable for other classes as specified by the associated acceptance criteria.

The target, acceptable and nonconforming conditions depicted herein and the associated acceptance criteria are intended to represent typical industrial practices. Requirements of individual product designs may deviate from these criteria.

The examples shown in the photographs and/or illustrations are sometimes exaggerated to make the referenced imperfection more apparent. The relationship between the text and the examples is not always parallel; it would be difficult to find many cases so specific that they would always match the acceptance criteria. When photographs or illustrations contained in this standard are not consistent with discussion in the written Text, the written text takes precedence and should be followed.

It should also be noted that some of the photographs used may have more than one type of condition on the same example. It is necessary that the users of this document pay particular attention to the subject of each section to avoid misinterpretation.

It should be understood that the first inference to nonconformance given implies that all other conditions of lesser magnitude are acceptable. Thus, a criteria which states a nonconformance condition as 50% of the surface is pitted, for example, implies that anything less than 50% of the surface being pitted is acceptable for that characteristic in that class. Obviously, nonconformance in Class 1 implies nonconformance in Classes 2 and 3; and likewise, nonconformance for Class 2 implies nonconformance in Class 3.

An inspector **shall not** make the selection as to which class the part under inspection belongs. When making accept and/or nonconformance decisions, the awareness of precedence of documentation must be maintained, i.e., typically contract, procurement documentation, specifications and referenced documents.

In all cases, documentation should be available to the inspector defining to which class the part submitted for inspection belongs.

Procedures and requirements for conducting visual inspections related to this document **shall** be in accordance with the requirements of the applicable performance specification.

In the event of conflict, the following order of precedence **shall** apply:

1. Procurement documentation.
2. Procurement documentation reflecting the customers detailed requirements.

1.0 INTRODUCTION

Introduction (cont.)

3. Other documents to the extent specified by the customer.
4. The end item performance specification such as the IPC-6010 series when invoked by the customer.
5. This acceptability document.

Printed boards should be of uniform quality and **shall** conform to the IPC-6010 series.

IPC-6010 series establishes the minimum acceptability requirements for printed boards. This document, IPC-A-600, is a companion and complementary document, providing pictorial interpretation of these requirements.

IPC-A-600 can be used as a support document for inspection. It does not specify frequency of in-process inspection or frequency of end product inspection. Nor is the allowable number of nonconforming process indicators or the number of allowable repair/rework of defects specified.

Visual examination for applicable attributes **shall** be conducted at 3 diopters (approximately 1.75X). If the acceptable condition of a suspected defect is not apparent, it should be verified at progressively higher magnifications (up to 40X) to confirm that it is a defect. Dimensional requirements such as spacing or conductor width measurements may require other magnifications and devices with reticles or scales in the instrument, which allow accurate measurements of the specified dimensions. Contract or specification may require other magnifications.

Plated-through holes **shall** be internally examined for foil and plating integrity at a magnification of 100X. Referee examinations **shall** be accomplished at a magnification of 200X.

Automated Inspection Technology (AIT) results may be applicable to the evaluation of many of the dimensional characteristics illustrated in this document.

1.6 APPLICABLE DOCUMENTS¹

The following documents form a part of this document to the extent specified herein. The revision of the document in effect at the time of solicitation **shall** take precedence.

J-STD-003 Solderability Tests for Printed Boards

IPC-T-50 Terms and Definitions for Interconnecting and Packaging Electronic Circuits

IPC-TM-650 Test Methods Manual²

2.1.1E 05/04 Microsectioning

2.1.1.2A 05/04 Microsectioning, Semi or Automatic Technique Microsection Equipment (Alternate)

2.2.2 08/97 Optical Dimensional Verification

2.2.7A 05/86 Hole Size Measurement, Plated

2.3.25C 02/01 Detection and Measurement of Ionizable Surface Contaminants

2.3.26B 08/97 Ionizable Detection of Surface Contaminants (Dynamic Method)

2.4.1E 05/04 Adhesion, Tape Testing

2.4.15A 03/76 Surface Finish, Metal Foil

2.4.22C 06/99 Bow and Twist

2.4.28.1D 05/04 Adhesion, Solder Resist (Mask), Tape Test Method

2.6.3F 05/04 Moisture and Insulation Resistance

IPC-SM-840 Qualification and Performance of Permanent Solder Mask

IPC-2220 Series of Design Standards for Printed Boards

IPC-6010 Series of Performance Specifications for Printed Boards

IPC-9191 General Requirements for Implementation of Statistical Process Control

1.7 DIMENSIONS AND TOLERANCES

All dimensions and tolerances specified herein are applicable only to the end product. Dimensions are expressed in hard SI (metric) units and parenthetical soft imperial [inch] units.

Reference information is shown in parentheses ().

1.8 TERMS AND DEFINITIONS

Terms and definitions **shall** be in accordance with IPC-T-50.

1.9 WORKMANSHIP

Printed boards fabricated to the requirements of this document **shall** be processed in such a manner as to be uniform in quality and to preclude the introduction of dirt, foreign matter, oil, fingerprints, flux residues, or other contaminants that may affect the life or serviceability of the product. Printed boards **shall** be free of defects in excess of those allowed by this document. Acceptance of imperfections not specifically covered by this document **shall** be agreed upon by the user and supplier of the product.

1. www.ipc.org

2. Current and revised IPC Test Methods are available through IPC-TM-650 subscription and on the IPC Web site (www.ipc.org/html/testmethods.htm).

2.0 EXTERNALLY OBSERVABLE CHARACTERISTICS

Introduction

This section addresses those characteristics which are observable from the surface. This includes those characteristics that are external and internal in the printed board but visible from the surface as follows:

- **Surface Imperfections** such as burrs, nicks, scratches, gouges, cut fibers, weave exposure and voids.
- **Subsurface Imperfections** such as foreign inclusions, measling/crazing, delamination, pink ring and laminate voids.
- **Imperfections in Conductive Pattern** such as loss of adhesion, reduction of conductor width or thickness due to nicks, pin-holes, scratches, surface plating or coating defects.
- **Hole Characteristics** such as diameter, misregistration, foreign material, and plating or coating defects.
- **Marking Anomalies** including location, size, readability, and accuracy.
- **Solder Resist Surface Coating Imperfections** such as misregistration, blisters, bubbles, delamination, adhesion, physical damage and thickness.
- **Dimensional Characteristics** including printed board size and thickness, hole size and pattern accuracy, conductor width and spacing, registration and annular ring.

2.1 Board Edges

Imperfections such as burrs, nicks or haloing along the edge of the board are acceptable provided they do not exceed the limits below.

2.1.1 Burrs

Burrs are characterized by small lumps or masses with an irregular shape, convex to a surface, and are a result of a machine process, such as drilling or gouging.

2.1 BOARD EDGES

2.1.1.1 Nonmetallic Burrs



Target Condition – Class 1, 2, 3

- Edge conditions – smooth, no burrs.



Acceptable – Class 1, 2, 3

- Edge conditions – rough but not frayed.
- Edge conditions - loose burrs do not affect fit and function.

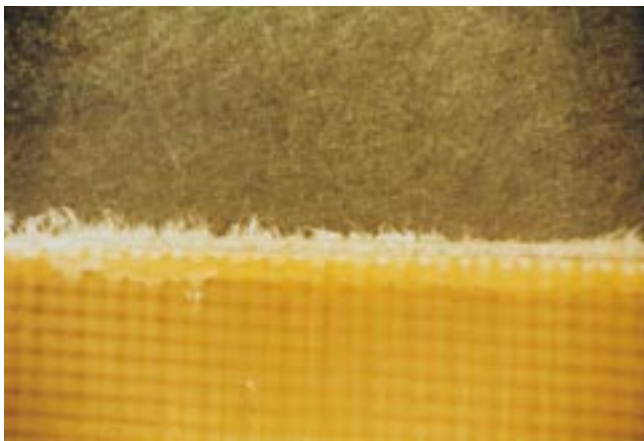

Nonconforming – Class 1, 2, 3

- Defects either do not meet or exceed above criteria.

2.1 BOARD EDGES

2.1.1.2 Metallic Burrs



Target Condition – Class 1, 2, 3

- Edge condition - smooth, no burrs.



Acceptable – Class 1, 2, 3

- Edge condition - rough but not frayed.
- Edge condition - no loose burrs.



Nonconforming – Class 1, 2, 3

- Defects either do not meet or exceed above criteria.

2.1 BOARD EDGES

2.1.2 Nicks



Target Condition – Class 1, 2, 3

- Edge condition – smooth, no nicks.



Acceptable – Class 1, 2, 3

- Edges are rough but not frayed.
- Nicks do not extend more than 50% of the distance from the edge of the board to the closest conductor or are greater than 2.5 mm [0.0984 in] whichever is less.



Nonconforming – Class 1, 2, 3

- Defects either do not meet or exceed above criteria.

2.1 BOARD EDGES

2.1.3 Haloing



Target Condition – Class 1, 2, 3

- No haloing.

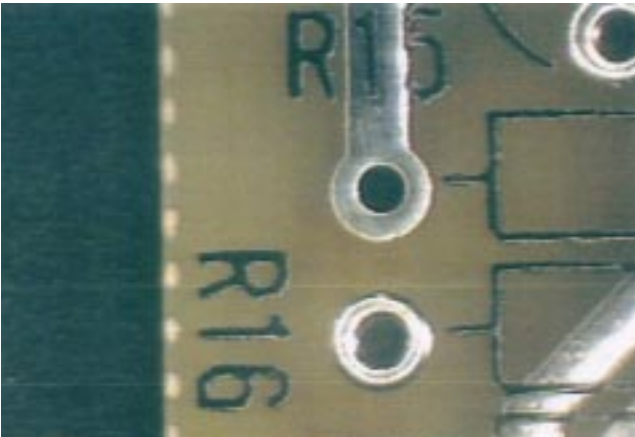

Acceptable – Class 1, 2, 3

- Penetration of haloing does not reduce the unaffected distance from the board edge to the closest conductive pattern by more than 50% or more than 2.5 mm [0.0984 in], whichever is less.

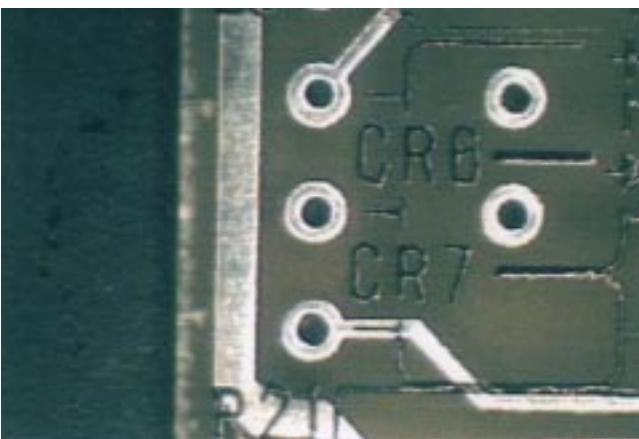

Nonconforming – Class 1, 2, 3

- Defects either do not meet or exceed above criteria.

2.2 BASE MATERIAL

Introduction

Identification of Imperfections

Much confusion has existed in the industry regarding the identification of defects that exist in laminates. To help identify those conditions, refer to the following sections where definitions, illustrations and photographs have been provided which precisely define and identify the following conditions:

Surface 2.2

- weave exposure 2.2.1
- weave texture 2.2.2
- exposed/disrupted fibers 2.2.3
- pits and voids 2.2.4

Subsurface 2.3

- measling 2.3.1
- crazing 2.3.2
- delamination/blistering 2.3.3
- foreign inclusions 2.3.4

It is important to note that laminate defect conditions may exist when the fabricator receives the material from the laminator, or may become apparent during the fabrication of the printed board. Some defects may be induced during processing.

The Use of Acceptability Criteria

Everyone cannot be an expert on laminate defects. Some nondestructive visual criteria must be established to aid in making a decision regarding acceptability levels.

2.2 BASE MATERIAL SURFACE

2.2.1 Weave Exposure

Weave Exposure: A surface condition of base material in which the unbroken fibers of woven cloth are not completely covered by resin.

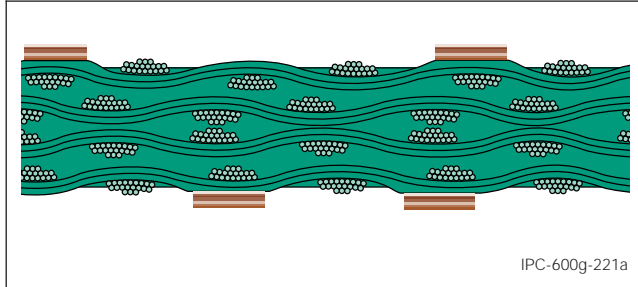

Note: This graphic is for illustrative purposes only and does not require a microsection evaluation.

Acceptable – Class 1, 2, 3

- Excluding the area(s) with weave exposure, the remaining space between conductors meets the minimum conductor spacing requirement.

Nonconforming – Class 1, 2, 3

- Defects either do not meet or exceed above criteria.

2.2 BASE MATERIAL SURFACE

2.2.2 Weave Texture

Weave Texture: A surface condition of base material in which a weave pattern of cloth is apparent although the unbroken fibers of woven cloth are completely covered with resin.

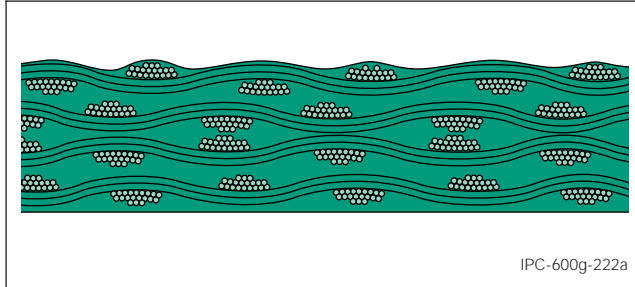

Note: This graphic is for illustrative purposes only and does not require a microsection evaluation.

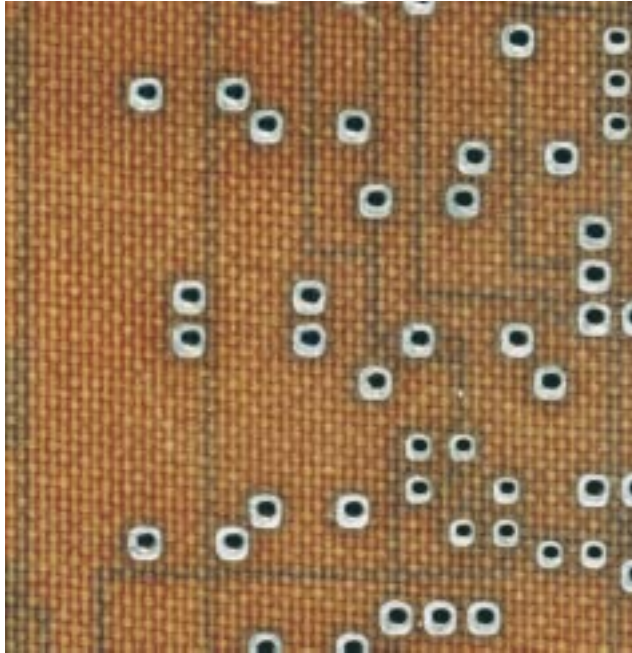

Acceptable – Class 1, 2, 3

- Weave texture is an acceptable condition in all classes but is sometimes confused with weave exposure because of similar appearances.

This example could be either weave exposure or weave texture. The difference cannot be determined from this view. The difference can be discerned using nondestructive tests (oblique illumination with microscope) or microsection.

2.2 BASE MATERIAL SURFACE

2.2.3 Exposed/Disrupted Fibers

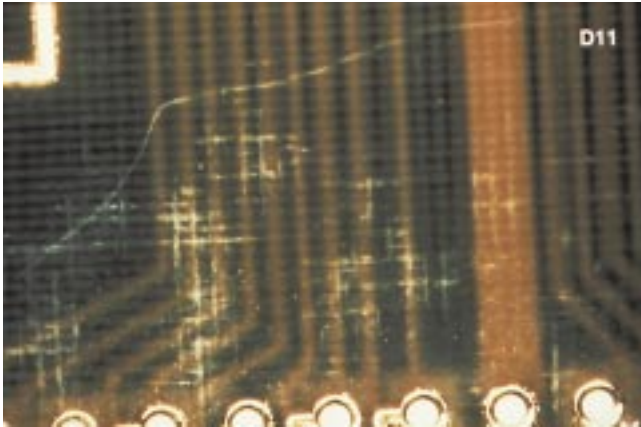

Acceptable – Class 1, 2, 3

- Exposed or disrupted fibers do not bridge conductors and do not reduce the conductor spacing below the minimum requirements.

Nonconforming

- Defects either do not meet or exceed above criteria.

2.2 BASE MATERIAL SURFACE

2.2.4 Pits and Voids



Target Condition – Class 1, 2, 3

- No pits or voids.

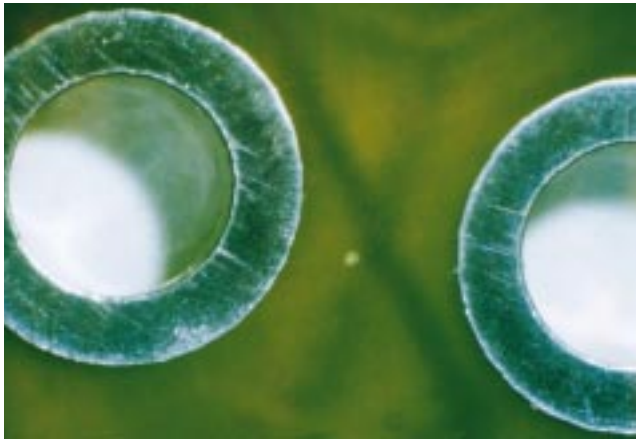

Acceptable – Class 1, 2, 3

- Pits or voids do not exceed 0.8 mm [0.031 in].
- Total board area affected is less than 5% per either side.
- Pits or voids do not bridge conductors.

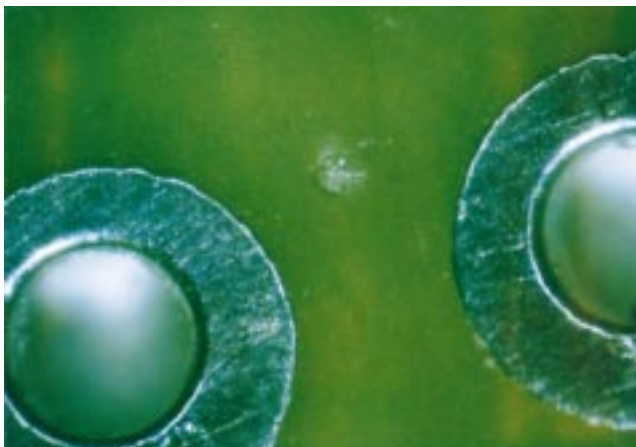

Nonconforming – Class 1, 2, 3

- Defects either do not meet or exceed above criteria.

2.3 BASE MATERIAL SUBSURFACE

Introduction

This section is focused on those subsurface conditions of laminated base materials that are externally observable through the base material itself and some solder resist coatings. The most frequent subsurface base materials conditions are termed measling, crazing, delamination, blistering and foreign materials. These conditions may be observed throughout the printed board manufacturing and inspection process; such as:

- During incoming metal-clad base material evaluations after being manufactured by the laminator,
- By the printed board manufacturer after having removed (etched) the metal-cladding in the preparation of "inner-layer" details for multilayer printed boards,
- After etching the "outer" layers of printed boards to form the required arrangement of conductive patterns and markings,
- After baking operations (such as solder resist or component legends),
- After thermal shock, as in solder fusing/coating or solderability testing processes.

Base material subsurface conditions have been the subject of considerable discussion within the printed board industry for several decades. Of the several subsurface conditions, measling and crazing continue to cause the most concerns. Measles and crazing have been the primary focus of two IPC "Blue Ribbon Committees" of experts. The following are brief summaries and additional comments from the IPC's Blue Ribbon Committee:

Brief summary of the First IPC Blue Ribbon Committee on Measles

The committee conducted a wide overview of printed board base material surface and subsurface conditions with a major focus on measles. IPC's "Measles in Printed Wiring Boards, Information Document" was published in 1973 as a result of this effort. The committee was to collect as much data as was available on measles and other surface/subsurface conditions; and to standardize the terms, definitions (descriptions), photographs, and illustrations of surface and subsurface conditions. It was felt that sufficient research had been done by industry and that a position on "measles" could be prepared by the committee. The committee's recommendation was as follows, "comprehensive review of available literature and available research and test data, that while measles may be objectionable cosmetically, their effect on functional characteristics of finished products, are at worst minimal, and in most cases insignificant."

Comments: Despite the committee's recommendation and industry data, there was still a strong reluctance by most gov-

ernment and industry personnel to accept that measles are a cosmetic condition with no functional effect in most applications. Most companies continued to retain "no measling" requirements in their specifications. But when measles or other nonconforming surface/subsurface conditions had severe impact on their production schedules, the customer (or acceptance agency) would produce a document that established acceptance guidelines for measles (and frequently other surface and subsurface conditions). The new guidelines were based on size, percent reduction in conductor spacing, and amount of affected area. They also varied from customer-to-customer. As technology evolved, in particular reductions in conductor spacing, the effect of measling and other surface/subsurface conditions once again became a serious industry wide concern. As a result, a second IPC Blue Ribbon Committee on Measles was formed.

Brief summary of the Second IPC Blue Ribbon Committee on Measles

The committee was formed in late 1978. This committee reviewed the findings of the first committee, solicited the industry for additional data, and reviewed the proprietary acceptance criteria provided by IPC members. The Second Blue Ribbon Committee came to the same conclusion. Measles are a cosmetic process indicator and had almost no reported effects on a product's functional performance in most applications. The major exception was high voltage applications. There was still reluctance by some government organizations and a few industrial companies to categorically accept measles. As such, this committee established a set of measling/crazing requirements that obtained consensus from all IPC members. The result was a matrix of acceptance limitations for the three major phases of the printed board electronic assembly process: laminated material, printed board final inspection, and after printed board assembly. These requirements included percent reductions in conductor spacing (not exceeding minimum conductor spacing), and various amounts of measled area for each side of the printed board (or assembly) based on the Class of product. These requirements were added as an amendment to the first printing of the IPC-A-600, Revision C, and were included in later printings of the C revision and, in a different format, the IPC-A-600, Revision D.

Comments: The primary concerns expressed by the reluctant individuals are summarized in the following list (with comments):

- Electrical Insulation Resistance, both volume and surface - several reports and available test data indicates that insulation resistance is not significantly affected by measling or crazing.

2.3 BASE MATERIAL SUBSURFACE

Introduction (cont.)

- Contamination - the concern was that ionic materials could diffuse or be "pumped" (by alternating atmospheric pressure) into measles or crazing and would result in lower insulation resistance or conductive-anodic filament (CAF) growths, shorts. Salt spray tests indicated this was not a valid premise, and most ionic materials (such as salts) will not diffuse into the base material.
- Applied Voltages - high voltage applications are a concern (in particular where there is the possibility of "corona" in the measling or crazing) the dielectric strength is reduced by 20-50% in comparison to a similar nonmeasled/crazed area, in particular at altitudes greater than 20 km [12.43 miles].
- Environmental - most measling/crazing did not appear to increase in size or occurrence due to environmental testing.

IPC-A-600, Revision E, was the first revision to reflect the needs for surface mounted component technology. As such, the acceptance requirements for measling and crazing were separated. For measles, the acceptance requirements allowed bridging under surface conductor spacing. This was done based on the definition of measles, test data, and industry experience of measles having never been documented to cause a functional failure. Crazing is much less controlled separation in the base material forming "interconnections" between measles and possibly adjacent conductive patterns; therefore, the acceptance requirements for crazing were set the same as the similar conditions of delamination and blistering.

Over a period of time, governing specifications have become excessively heavy regarding the presence of measles. In addition, cosmetic appearance has become a major acceptance criterion. In actual fact, no failure has ever been attributed to measling, based on all military and industry testing to date. IPC, industry and various military agencies have conducted extensive testing in severely measled assemblies under extreme environmental conditions for long periods of time with no evidence of growth, spreading or any detriment to the function of the assembly. Measles should not be the cause for rejection.

Measling is an internal condition occurring in the woven fiber reinforced laminated base material in which the bundles are separated at the weave intersection. The term "crazing" is sometimes used to describe an array of measles which appear from the surface to be interconnected. When the measles look to be interconnected, this condition called "crazing" is a form of delamination in that there are separations along the length of the fiber/yarns and the resin. For nonwoven material, this condition resembles a measle but is randomly located and has an irregular shape (see Figure 1).

In a case study done, the prime cause of the observed measles was a combination of moisture, which diffuses readily into epoxy-glass, and component soldering temperatures. The application of local high temperatures for component mounting caused entrapped moisture to vaporize and break the epoxy-glass bond at the "knuckle" (intersection of the warp and fill of the e-glass cloth). From previous experience, it is known that epoxy-glass absorbs atmospheric moisture, and when moisture content exceeds 0.3 wt%, it can give rise to measling during solder dip/level and/or assembly soldering operations.

There are other factors that can contribute to measles/crazing such as: resin composition, method of making laminates, coupling agents, T_g , etc. In the past, reports were compiled which revealed that measles and crazing with over 50% spacing violation were not adverse to the reliability of the hardware. Why, if all test reports showed no problems with measles and no reported field failures, are we so concerned about measles and crazing? Because it appears feasible, in theory, that if measles with 100% conductor spacing violation combines with moisture or some other contaminant, copper migration (Insulation resistance, or IR, failures) should be experienced between conductors.

Even when the potential failure mechanism mentioned above is analyzed, it is almost impossible to experience such insulation resistance (IR) or migration failure. First, a measle(s) gapping conductive patterns is needed. Secondly, moisture in the printed board/assembly, along with a conductive or ionic contaminant such as chlorides, is necessary.

2.3 BASE MATERIAL SUBSURFACE

Introduction (cont.)

In this instance, a typical industry example, the measle is at the center between two plated through holes (see Figure 2). The measle is 0.35 mm [0.0138 in] wide. In order to get possible copper migration, the measle had to gap the two plated through holes. This of course would be most unlikely. The second example (see Figure 3) illustrates what is required for a potential failure mechanism between two surface conductors. A (+) conductor directly over a knuckle is required and a (-) conductor is also required directly over a knuckle. For an electrical short to occur between these conductors through the base material, there would need to be a conductive path from one conductive pattern, through the remaining dielectric materials (resin and yarn) to the separation (measle), along the separation in the direction of the other conductive pattern, once again through the remaining dielectric materials (resin and yarn), and to the second conductive pattern. In order to induce a failure all of the above mentioned ingredients are required along with a voltage potential between two adjacent conductors. This occurrence is highly unlikely and is most likely why the industry has not experienced any adverse reliability problems due to measles.

When making acceptance calls on electronic hardware, consider all the possible concerns mentioned above. Measles should not be considered a nonconforming condition. It should instead be considered a process indicator, telling you that the process is on the verge of going out of control. Correct the problem, but do not scrap the product, taking into account all of the above mentioned variables.

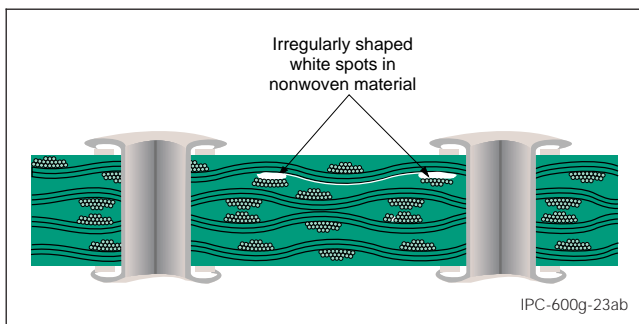

Figure 1
Note: This graphic is for illustrative purposes only and does not require a microsection evaluation.

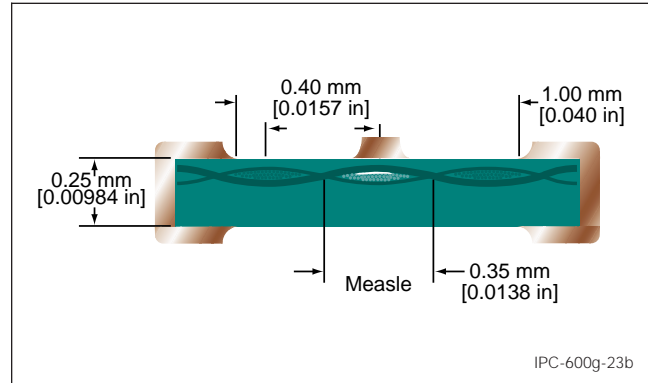

Figure 2
Note: This graphic is for illustrative purposes only and does not require a microsection evaluation.

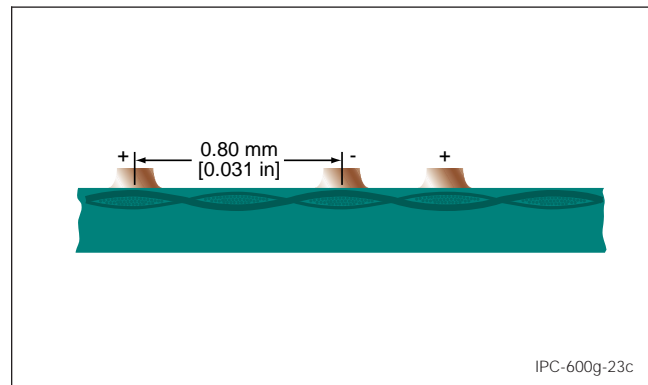
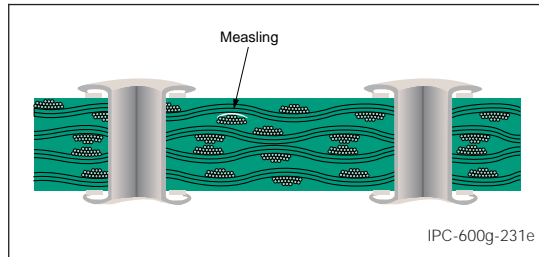

Figure 3
Note: This graphic is for illustrative purposes only and does not require a microsection evaluation.

2.3 BASE MATERIAL SUBSURFACE

2.3.1 Measling

Measling: Measling manifests itself in the form of discrete white squares or “crosses” below the surface of the base material, and is usually related to thermally induced stress. Measles are subsurface phenomena that have been found in new laminated materials and in every board type made from woven fiber reinforced laminates at one time or another. Since measles are strictly subsurface phenomena and occur as a separation of fiber bundles at fiber bundle intersections, their apparent positions relative to surface conductors have no significance.



Note: This graphic is for illustrative purposes only and does not require a microsection evaluation.

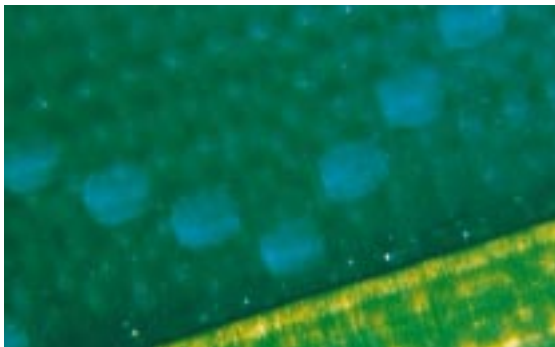

Acceptable – Class 1, 2, 3

- Measles are acceptable for all products, except for high-voltage applications as defined by the customer.

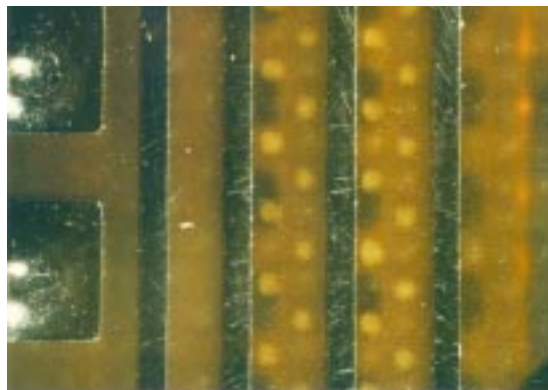

Note: Measles are observed from the surface. Cross-sections are for illustration purposes only.

2.3 BASE MATERIAL SUBSURFACE

2.3.2 Crazing

Crasing: An internal condition occurring in the laminated base material in which the fibers within the yarn are separated. This can occur at the weave intersections or along the length of the yarn. This condition manifests itself in the form of connected white spots or "crosses" below the surface of the base material, and is usually related to mechanically induced stress. When the crosses are connected the condition is evaluated as follows:

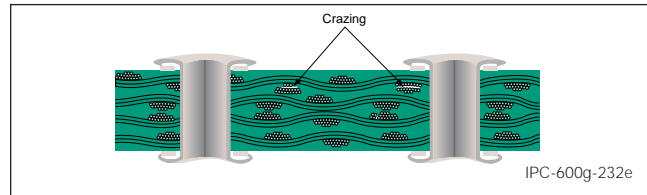

Note: This graphic is for illustrative purposes only and does not require a microsection evaluation.

Target Condition – Class 1, 2, 3

- No evidence of crasing.

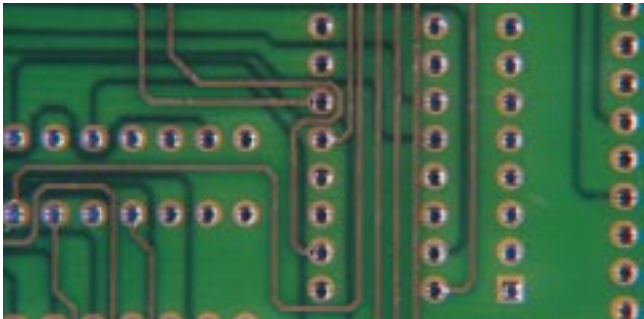

Acceptable – Class 2, 3

- The imperfection does not reduce the space between conductive patterns below the minimum conductor spacing.
- The distance of crasing does not span more than 50% of the distance between adjacent conductive patterns that are not electrically common.
- No propagation as a result of thermal testing that replicates the manufacturing process.
- Crasing at the edge of the board does not reduce the minimum distance between board edge and conductive pattern; or more than 2.5 mm [0.0984 in] if not specified.

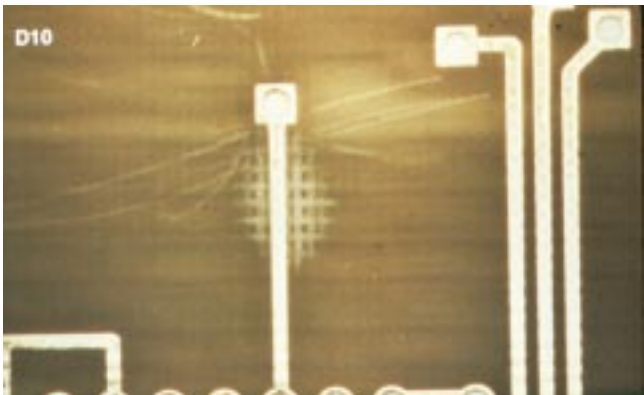

Acceptable – Class 1

- The imperfection does not reduce the space between conductive patterns below the minimum conductor spacing.
- No propagation as a result of thermal testing that replicates the manufacturing process.
- Crasing at the edge of the board does not reduce the minimum distance between board edge and conductive pattern; or more than 2.5 mm [0.0984 in] if not specified.

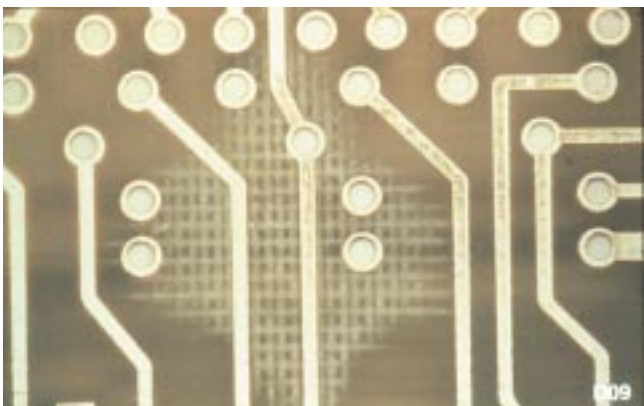

Nonconforming - Class 1, 2, 3

- Defects either do not meet or exceed above criteria.

Note: Crasing is observed from the surface. Cross-sections are for illustration purposes only.

2.3 BASE MATERIAL SUBSURFACE

2.3.3 Delamination/Blister

Delamination: A separation between plies within a base material, between a material and conductive foil, or any other planar separations within a printed board.

Blister: Delamination in the form of a localized swelling and separation between any of the layers of a lamination base material, or between base material and conductive foil or protective coating.

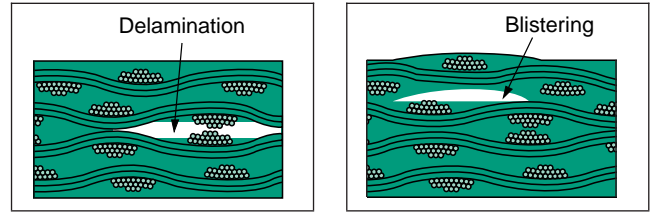
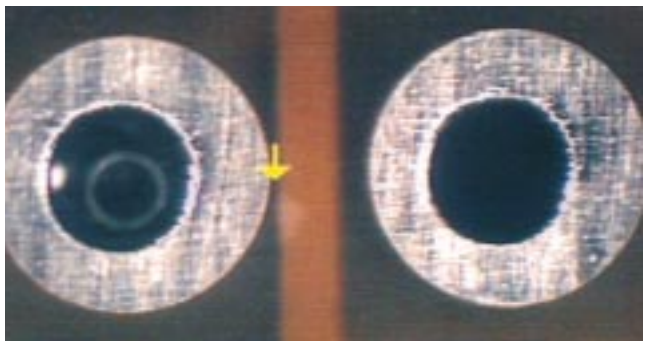
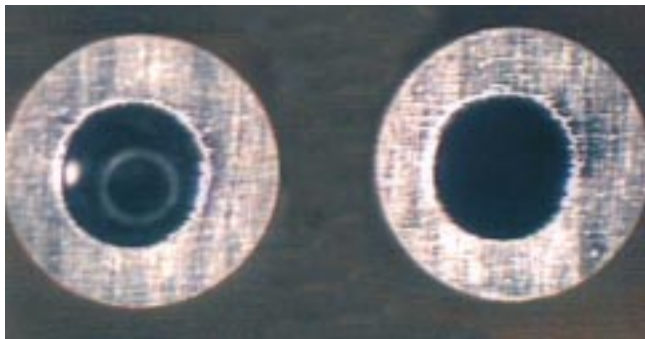
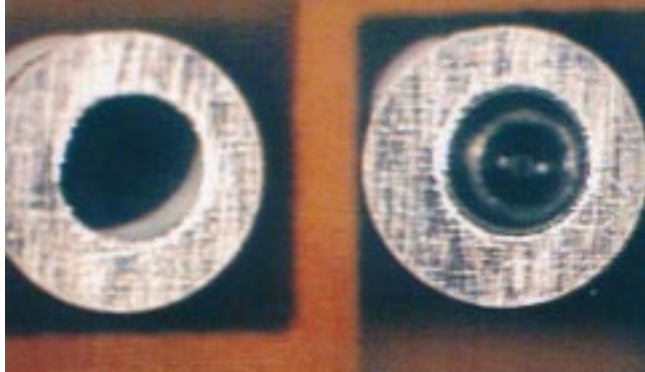

Note: This graphic is for illustrative purposes only and does not require a microsection evaluation.

Target Condition – Class 1, 2, 3

- No blistering or delamination.

Acceptable – Class 2, 3

- The area affected by imperfections does not exceed 1% of the board area on each side.
- The imperfection does not reduce the space between conductive patterns below the minimum conductor spacing.
- The blister or delamination does not span more than 25% of the distance between adjacent conductive patterns.
- No propagation as a result of thermal testing that replicates the manufacturing process.
- Are no closer to the edge of the board than the specified minimum distance between board edge and conductive pattern; more than 2.5 mm [0.0984 in] if not specified.

Acceptable – Class 1

- The area affected by imperfections does not exceed 1% of the board area on each side.
- The blister or delamination spans more than 25% of the distance between conductors, but does not reduce the space between conductor patterns below the minimum conductor spacing.
- No propagation as a result of thermal testing that replicates the manufacturing process.
- Are no closer to the edge of the board than the specified minimum distance between board edge and conductive pattern; more than 2.5 mm [0.0984 in] if not specified.

Nonconforming - Class 1, 2, 3

- Defects either do not meet or exceed above criteria.

Note: The area affected is determined by combining the area of each imperfection and dividing by the total area of the printed board. A separate determination is made for each side.

2.3 BASE MATERIAL SUBSURFACE

2.3.4 Foreign Inclusions

Foreign Particles: Metallic or nonmetallic, which may be entrapped or embedded in an insulating material.

Foreign material may be detected in raw laminate, prepreg (B stage), or processed multilayer printed boards. The foreign objects may be conductive or nonconductive, both types may be nonconforming depending on size and location.

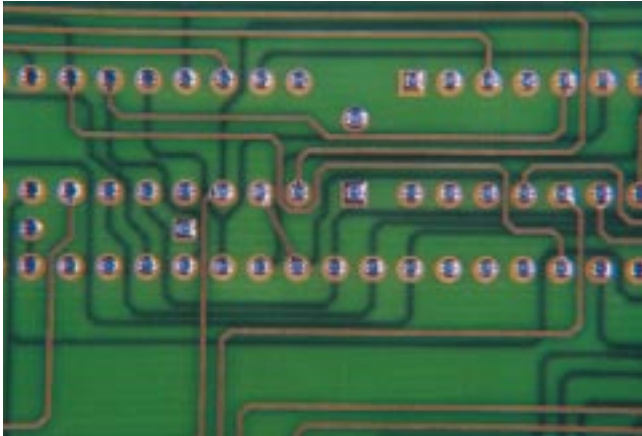

Target Condition – Class 1, 2, 3

- No foreign inclusions.



Acceptable – Class 1, 2, 3

- Translucent particles trapped within the board **shall** be acceptable.
- Opaque particles trapped within the board **shall** be acceptable provided the particle does not reduce the spacing between adjacent conductors to below the minimum spacing specified in the IPC-6010 series.
- Electrical parameters of the board are unaffected.



Nonconforming – Class 1, 2, 3

- Defects either do not meet or exceed above criteria.

2.4 SOLDER COATINGS AND FUSED TIN LEAD

2.4.1 Nonwetting

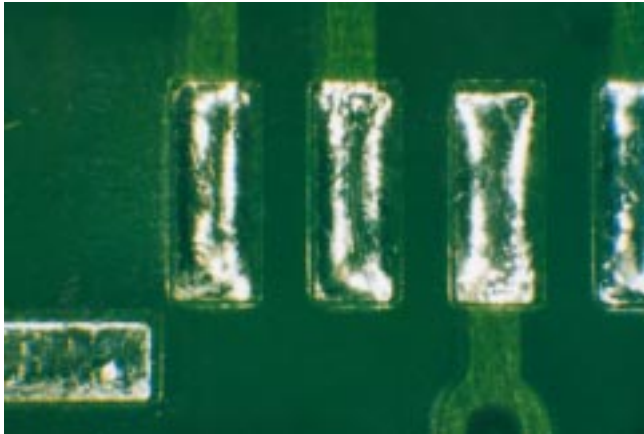

Target Condition – Class 1, 2, 3

- No nonwetting.

Acceptable - Class 1, 2, 3

- Complete wetting on all conductive surfaces where solder is not excluded by resist or other plating finish. Vertical sides (conductor and land) areas may not be covered.

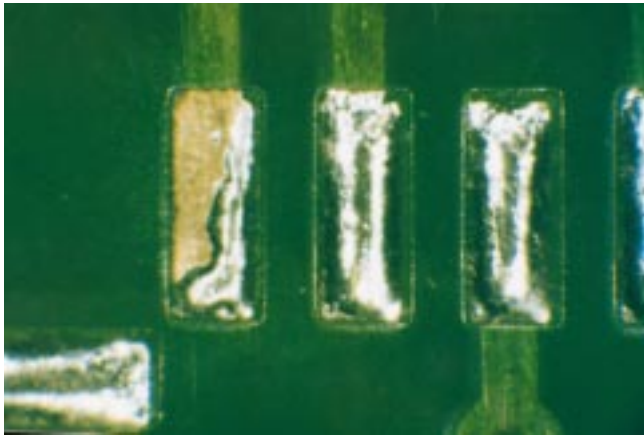

Nonconforming – Class 1, 2, 3

- Defects either do not meet or exceed above criteria.

2.4.2 Dewetting



Target Condition – Class 1, 2, 3

- No dewetting.

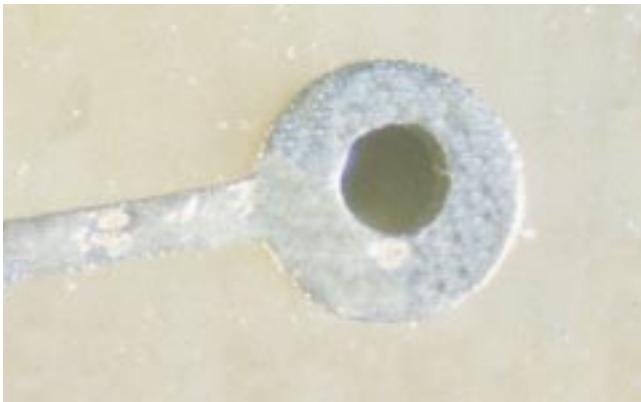

Acceptable – Class 2, 3

- On conductors and ground or voltage planes.
- On 5% or less of each land area for solder connection.

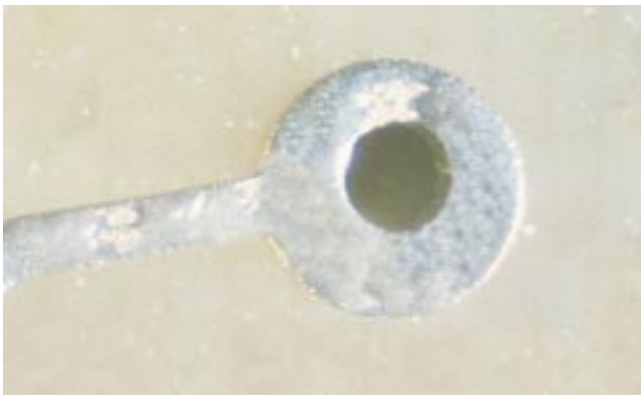

Acceptable – Class 1

- On conductors and ground or voltage planes.
- On 15% or less of each land area for solder connection.

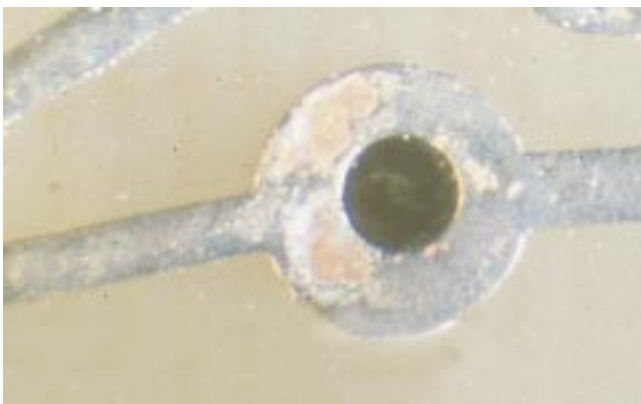

Nonconforming – Class 1, 2, 3

- Defects either do not meet or exceed above criteria.

2.5.1 Nodules/Burrs

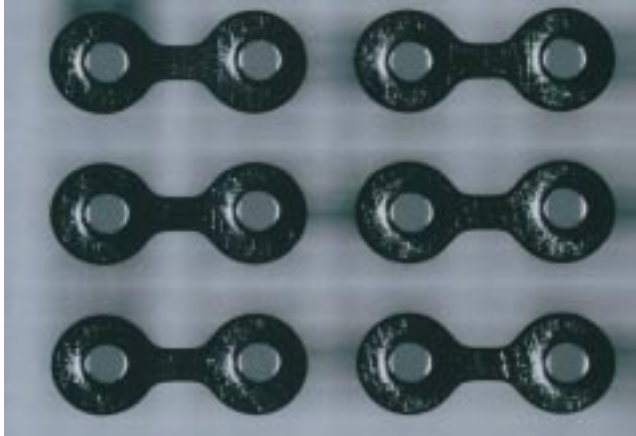

Target Condition - Class 1, 2, 3

- No evidence of nodules or burrs.

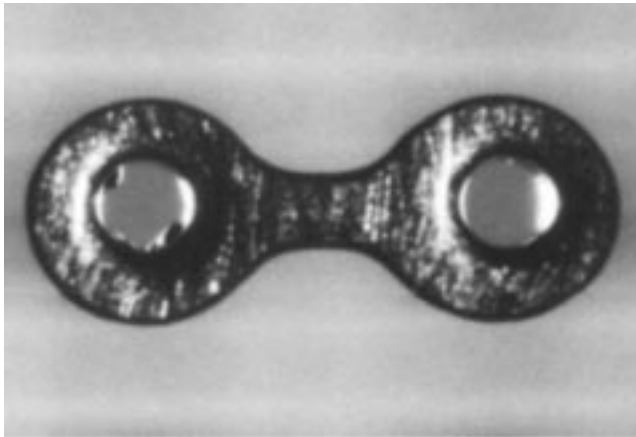

Acceptable - Class 1, 2, 3

- Allowed if minimum finished hole diameter is met.

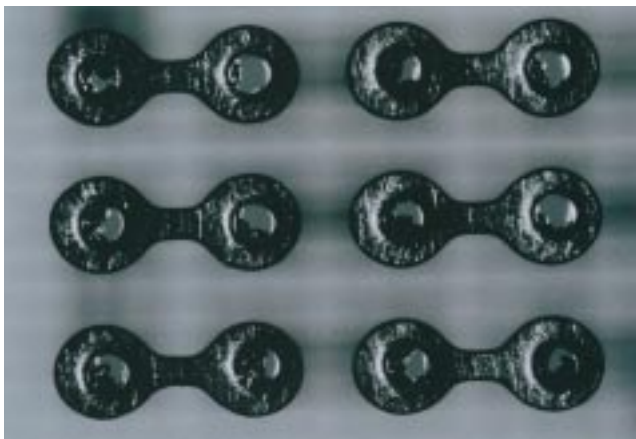

Nonconforming - Class 1, 2, 3

- Defects either do not meet or exceed above criteria.

2.5.2 Pink Ring

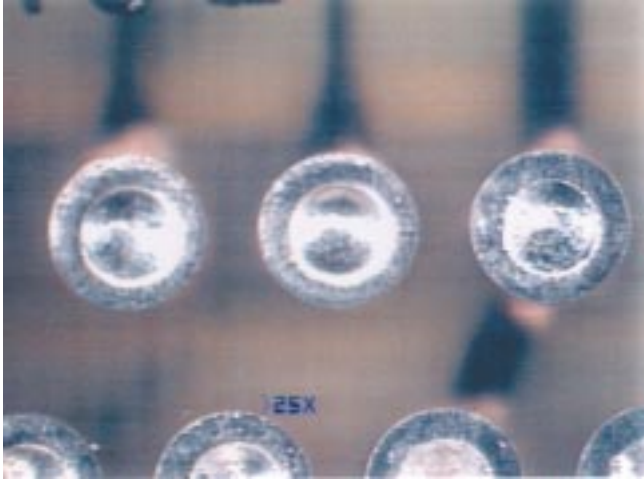

Acceptable - Class 1, 2, 3

- No evidence exists that pink ring affects functionality. The presence of excessive pink ring may be considered a process indicator but is not nonconforming. The focus of concern should be the quality of the lamination bond and hole cleaning and conditioning processes.

2.5 HOLES – PLATED-THROUGH – GENERAL

2.5.3 Voids – Copper Plating

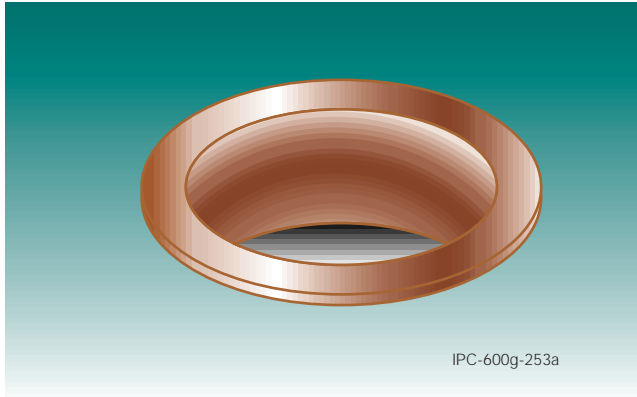

Target Condition – Class 1, 2, 3

- No voids

Acceptable – Class 3

- No evidence of voids in the hole.

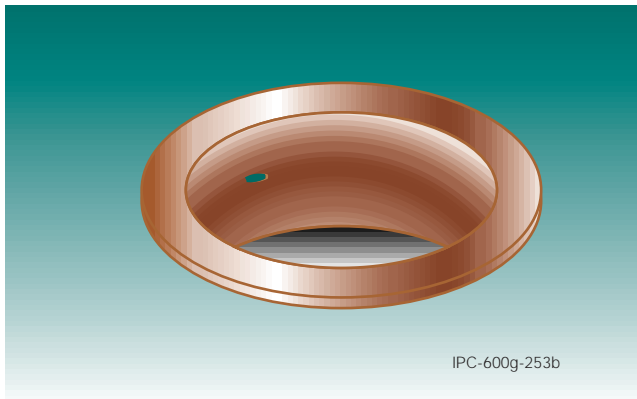

Acceptable – Class 2

- No more than one void in any hole.
- Not more than 5% of the holes have voids.
- Any void is not more than 5% of the hole length.
- The void is less than 90° of the circumference.

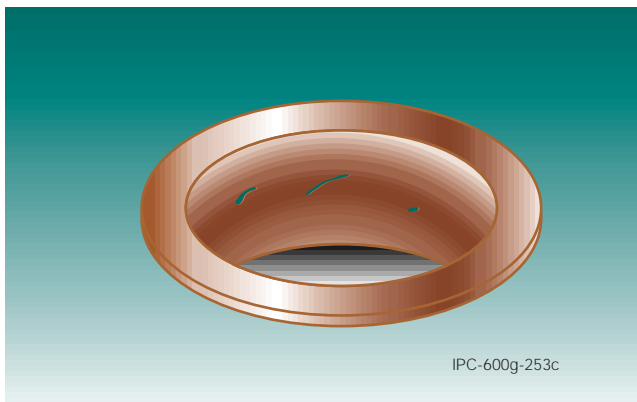

Acceptable – Class 1

- No more than three voids in any hole.
- Not more than 10% of the holes have voids.
- Any void is not more than 10% of the hole length.
- All voids are less than 90° of the circumference.

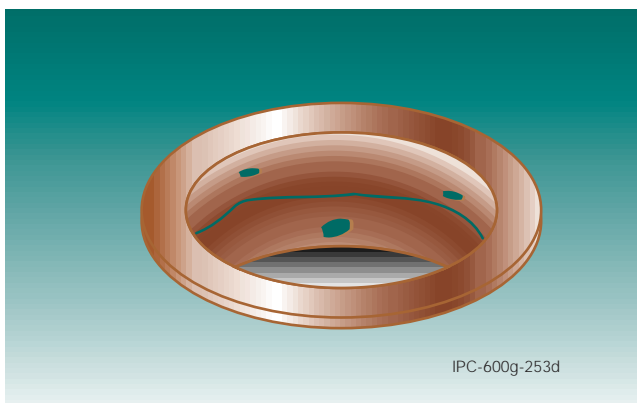

Nonconforming – Class 1, 2, 3

- Defects either do not meet or exceed the above criteria.

2.5.4 Voids - Finished Coating

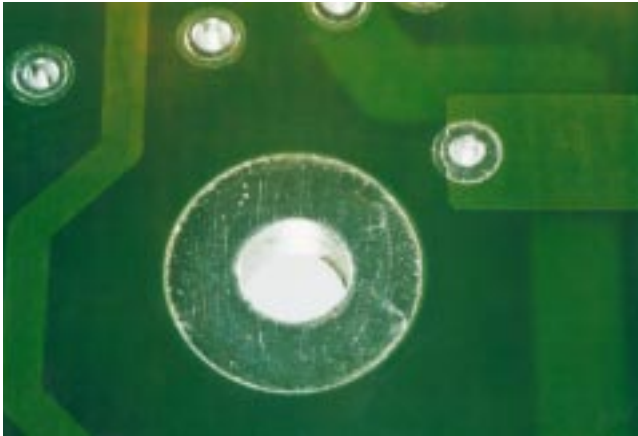

Target Condition - Class 1, 2, 3

- No voids

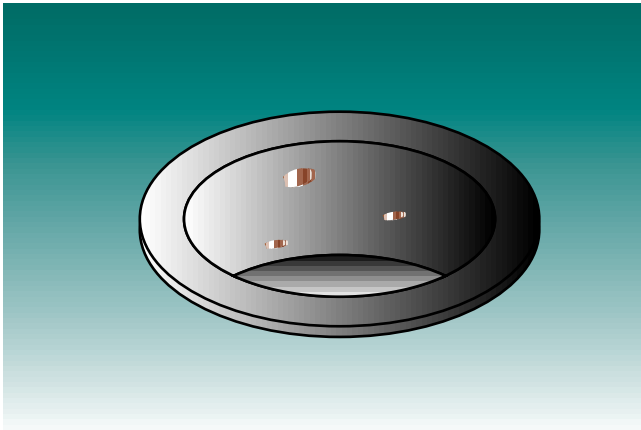

Acceptable - Class 3

- No more than one void in any hole.
- Not more than 5% of the holes have voids.
- The void is not more than 5% of the hole length.
- The void is less than 90° of the circumference.

Acceptable - Class 2

- No more than three voids in any hole.
- Not more than 5% of the holes have voids.
- Any void is not more than 5% of the hole length.
- All voids are less than 90° of the circumference.

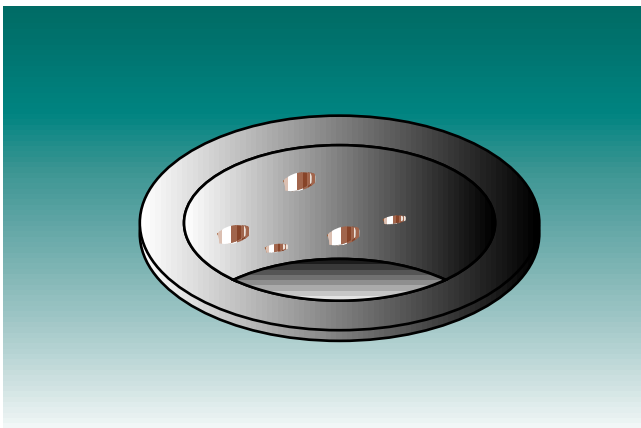

Acceptable - Class 1

- No more than five voids in any hole.
- Not more than 15% of the holes have voids.
- Any void is not more than 10% of the hole length.
- All voids are less than 90° of the circumference.

Nonconforming - Class 1, 2, 3

- Defects either do not meet or exceed above criteria.

2.5 HOLES - PLATED-THROUGH - GENERAL

2.5.5 Lifted Lands - (Visual)



Target Condition/Acceptable - Class 1, 2, 3

- No lifting of lands.

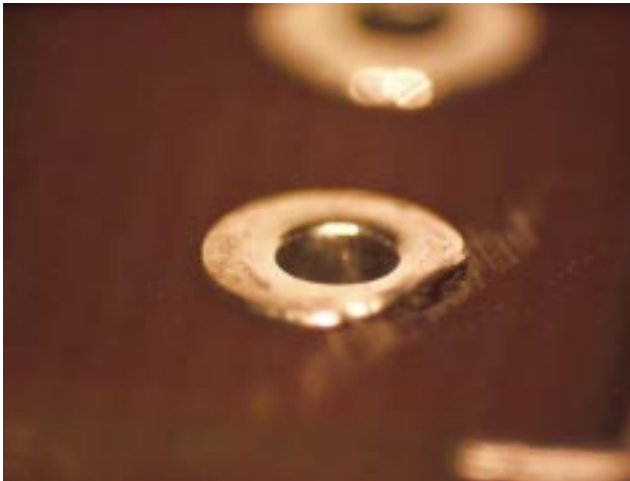

Nonconforming - Class 1, 2, 3

- Defects either do not meet or exceed above criteria.



2.6 HOLES - UNSUPPORTED

2.6.1 Haloing

Haloing: Mechanically induced fracturing or delamination on or below the surface of the base material; a light area around the holes, other machined areas or both are usually indications of haloing. See also 2.1.3.

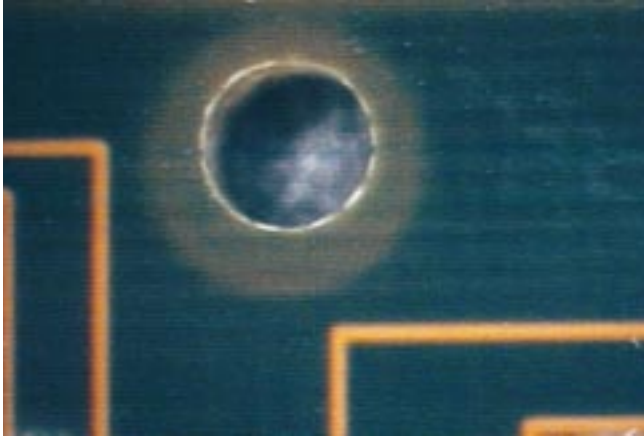

Target Condition – Class 1, 2, 3

- No haloing.

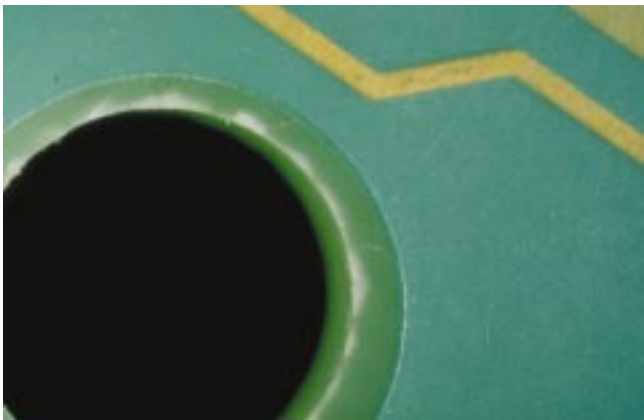

Acceptable – Class 1, 2, 3

- Penetration of haloing does not reduce the unaffected distance from the board edge to the closest conductive pattern by more than 50% or more than 2.5 mm [0.0984 in], whichever is less.



Nonconforming – Class 1, 2, 3

- Defects either do not meet or exceed above criteria.

2.7 PRINTED CONTACTS

2.7.1 Surface Plating – General

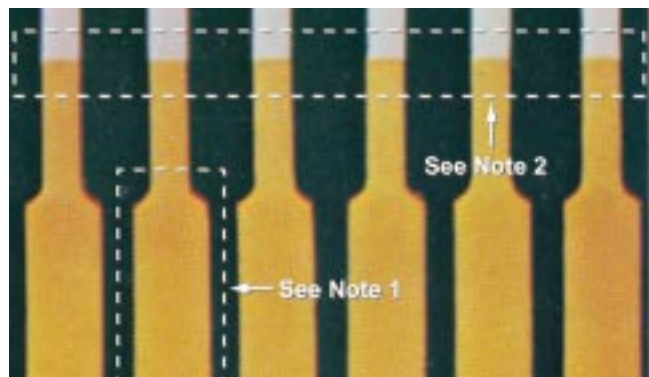

Target Condition – Class 1, 2, 3

- Contacts are free of pits, pinholes and surface nodules.
- No exposed copper or plating overlap between solder finish or solder mask and tip finish.

Acceptable – Class 1, 2, 3 (Critical Contact Area)

- Surface defects do not expose underlying metal in critical contact area.
- Solder splashes or tin-lead plating does not occur in critical contact area.
- No nodules and metal bumps in critical contact area.
- Pits, dents or depressions do not exceed 0.15 mm [0.00591 in] in their longest dimension. There are not more than three per contact, and they do not appear on more than 30% of the contacts.

Acceptable - Class 3 (Gap/Overlap Area)

- Exposed copper or plating overlap is 0.8 mm [0.031 in] or less.

Acceptable – Class 2 (Gap/Overlap Area)

- Exposed copper or plating overlap does not exceed 1.25 mm [0.04921 in].

Acceptable – Class 1 (Gap/Overlap Area)

- Exposed copper or plating overlap does not exceed 2.5 mm [0.0984 in].

Nonconforming - Class 1, 2, 3

- Defects either do not meet or exceed above criteria.

Note 1: Critical contact area. These conditions do not apply to a band 0.15 mm [0.00591 in] wide around the periphery of the printed contact land.

Note 2: Discoloration is permitted in the plating overlap zone.

2.7 PRINTED CONTACTS

2.7.1.1 Surface Plating - Wire Bond Pads

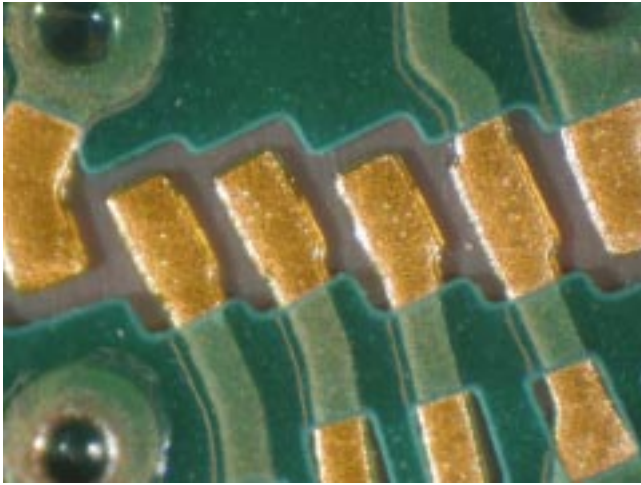

Target Condition – Class 1, 2, 3

- Contacts are free of surface nodules, roughness, electrical test witness marks or scratches that exceed $0.8\ \mu\text{m}$ [$32\ \mu\text{in}$] RMS (root-mean-square) in the pristine area in accordance with an applicable test method as agreed between user and supplier. If IPC-TM-650, Method 2.4.15, is used, it is recommended that the roughness-width cutoff be adjusted to approximately 80% of the maximum length of the wire bond pad in order to obtain the RMS value within the pristine area. For more information on surface roughness, refer to ASME B46.1
- The pristine area is defined as an area bounded in the center of the pad by 80% of the pad width and 80% of the pad length (see Figure 1).

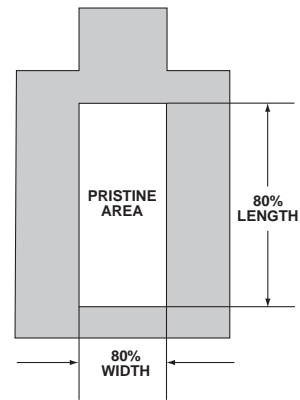
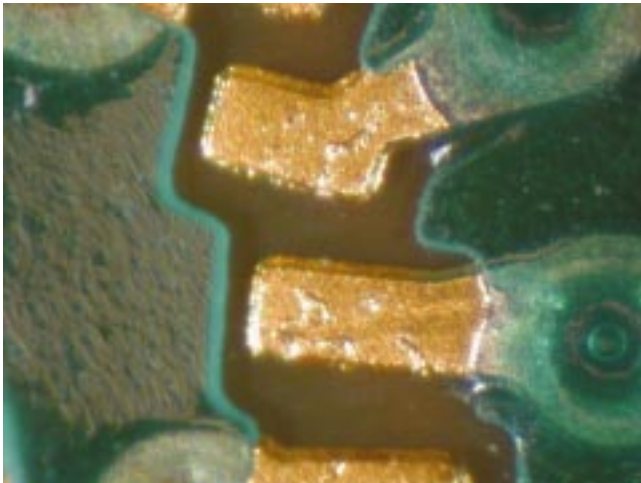
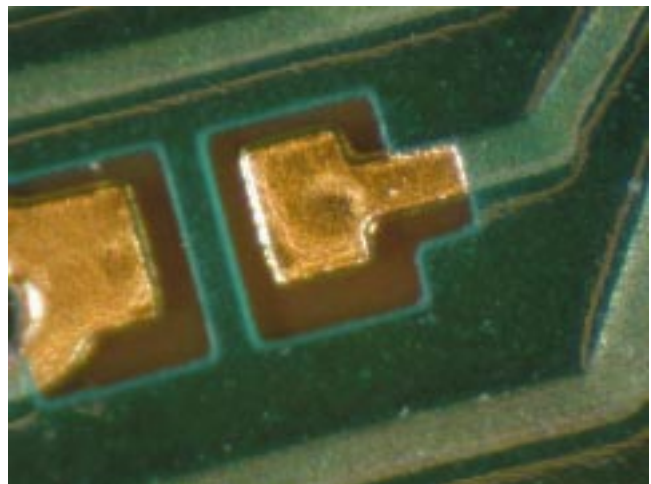
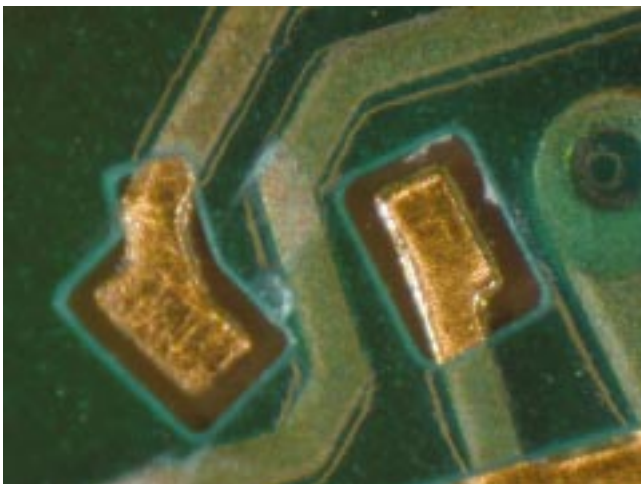

Figure 1 Wire Bond Pad Pristine Area

Nonconforming – Class 1, 2, 3

- Defects either do not meet or exceed the above criteria.



2.7 PRINTED CONTACTS

2.7.2 Burrs on Edge-Board Contacts



Target Condition – Class 1, 2, 3

- Smooth edge condition.

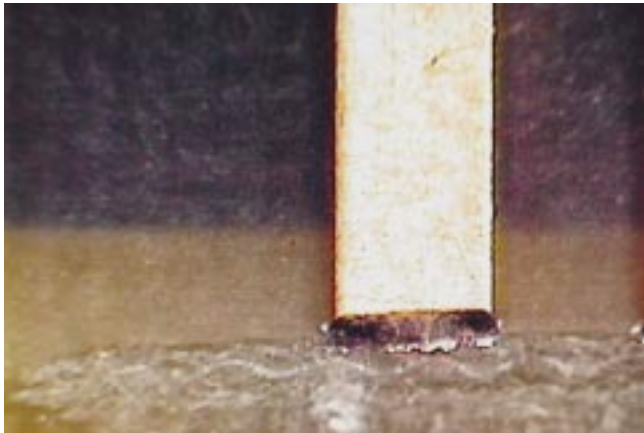

Acceptable – Class 1, 2, 3

- Edge condition - smooth, no burrs, no rough edges, no lifted plating on printed contacts, no separation (delamination) of printed contacts from the base material, and no loose fibers on the beveled edge. Exposed copper at end of printed contact is expected and permissible.

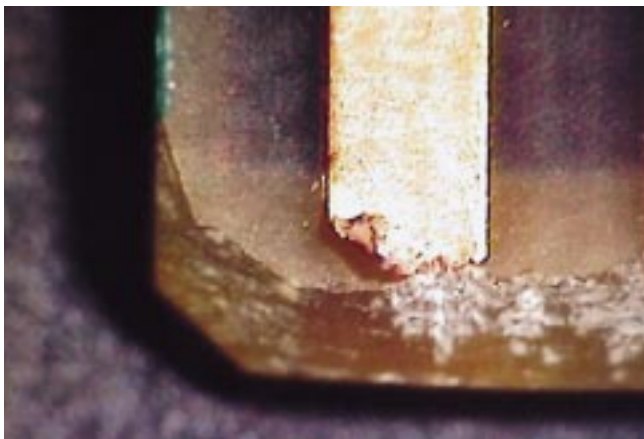

Nonconforming – Class 1, 2, 3

- Defects either do not meet or exceed the above criteria.

2.7 PRINTED CONTACTS

2.7.3 Adhesion of Overplate

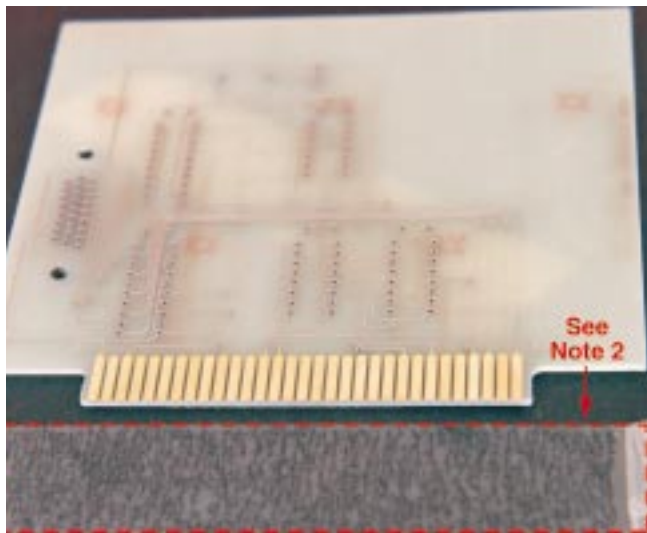

Acceptable – Class 1, 2, 3

- Good plating adhesion as evidenced by tape test. No plating removed. If overhanging metal breaks off and adheres to the tape, it is evident of overhang or slivers, but not of plating adhesion failure.

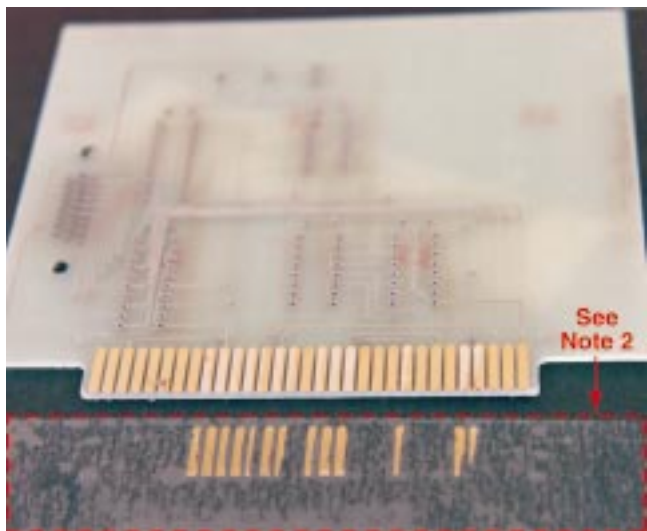

Nonconforming – Class 1, 2, 3

- Defects either do not meet or exceed the above criteria.

Note 1: The adhesion of the plating **shall** be tested in accordance with IPC-TM-650, Method 2.4.1, using a strip of pressure sensitive tape applied to the surface and removed by manual force applied perpendicular to the circuit pattern.

Note 2: Plating that has adhered to the tape.

2.8 MARKING

Introduction

This section covers acceptability criteria for marking of printed boards. Marking of printed boards provides a means of identification and aids in assembly. Legends screened over metal will generally degrade in a solder process or stringent cleaning environments. Legends over metal are not recommended. When use of legends over solder is required, an etched legend is target condition. Minimum requirements should be specified on the procurement documentation. Examples of the marking addressed by this section are:

- Assembly or fabrication part numbers when a requirement of the procurement documentation. Each individual board, each qualification board, and each set of quality conformance test circuitry (as opposed to each individual coupon) **shall** be marked in order to ensure traceability between the boards/test circuitry and the manufacturing history and to identify the supplier (logo, etc.).
- Component insertion locators, when a requirement of the procurement documentation.
- Manufacturing sequence number when required by the work order.
- Revision letter when the part number is a requirement of the procurement documentation.
- Designator for test points or adjustment points.
- Polarity or clocking indicators.
- U.L. designator.

The procurement documentation (artwork) is the controlling document for location and type of marking. The procurement documentation revision letter to which the board is fabricated **shall** be marked on the board if part number marking is a requirement of the procurement documentation. Marking on printed boards **shall** withstand all tests, cleaning and compatible processes to which the boards are subjected and **shall** be legible (capable of being read and understood) as defined by the requirements of this document.

The marking information on printed boards (part reference designations), **shall** be permanent and be capable of withstanding the environmental tests and cleaning procedures specified for the printed board. Marking **shall** be legible within the requirement of this document. The board **shall** be inspected at no greater magnification than 2X. When conductive inks are used they should meet the specifications of the IPC-6010 series.

This section has general requirements for all marking (including laser, labels, bar coding, etc.) and specific criteria for the following types of marking:

- Etched Markings.
- Screened or Ink Stamped Markings.

Unless otherwise specified, each individual board, each qualification board, each set of quality conformance test circuitry (as opposed to each individual coupon) is marked in accordance with the procurement documentation, with the date code and manufacturer's identification (e.g., cage code for military, logo, etc.). The marking is produced by the same process as used in producing the conductive pattern, or by use of permanent fungistatic ink or paint, or by vibrating pencil marking on a metallic area provided for marking purposes or a permanently attached label. Conductive markings, either etched copper or conductive black ink are considered as electrical elements of the board and should not reduce the electrical spacing requirements. All markings are to be compatible with materials and parts, legible for all tests, and in no case affect board performance.

Although it is acceptable to use impression stamp markings on unused portions of panels, they are not allowed on finished boards. Engraved marking or impression stamps and any mark that cuts into the laminate is handled in the same manner as a scratch.

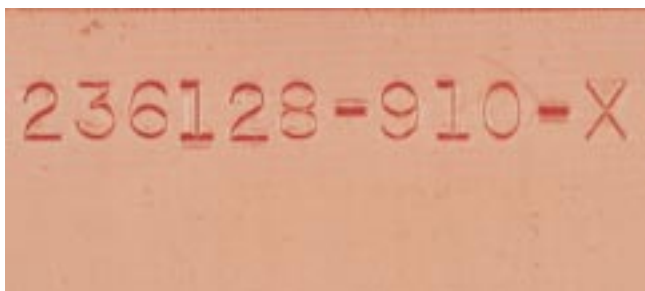

2.8 MARKING

2.8.1 Etched Marking

An etched marking is produced the same as the conductors on the printed board. As a result, the following criteria must be met for etched marking:



Target Condition – Class 1, 2, 3

- Characters are legible.
- Minimum conductor spacing requirements have also been maintained between etched symbolization and active conductors.

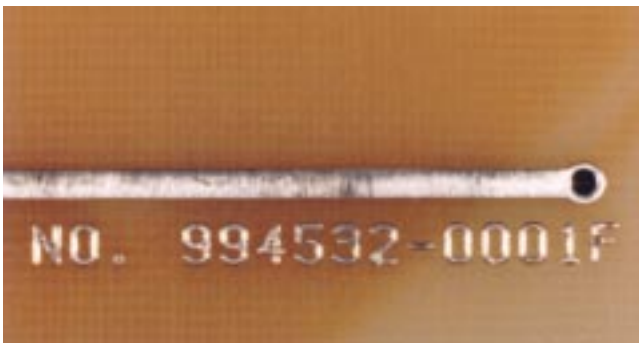

Acceptable – Class 3

- Marking defects are acceptable regardless of cause, (i.e., solder bridging, overetching, etc.) as long as characters are legible.
- Marking does not violate the minimum electrical clearance limits.
- Edges of the lines forming a character may be slightly irregular.

Acceptable – Class 2

- Marking defects are acceptable regardless of cause, (i.e., solder bridging, overetching, etc.) as long as characters are legible.
- Marking does not violate the minimum electrical clearance limits.
- Width of the lines forming a character may be reduced by up to 50%, providing they remain legible.



Acceptable – Class 1

- Marking defects are acceptable regardless of cause, (i.e., solder bridging, overetching, etc.) as long as characters are legible.
- Marking does not violate the minimum electrical clearance limits.
- Legends are irregularly formed but the general intent of the legend or marking is legible.

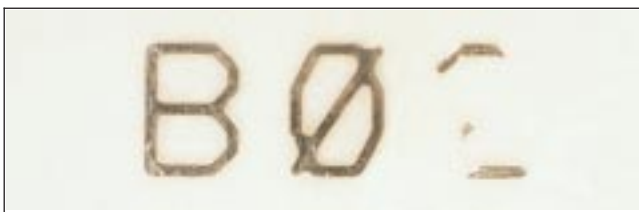

Nonconforming – Class 1, 2, 3

- Defects either do not meet or exceed above criteria.

2.8 MARKING

2.8.2 Screened or Ink Stamped Marking

Screened or ink stamped marking refers to any type of marking that is printed on top of the board. No cutting or etching is involved in producing this type of marking.



Target Condition – Class 1, 2, 3

- Characters are legible.
- Ink distribution is uniform, with no smearing or double images.
- Ink markings no closer than tangent to a land.

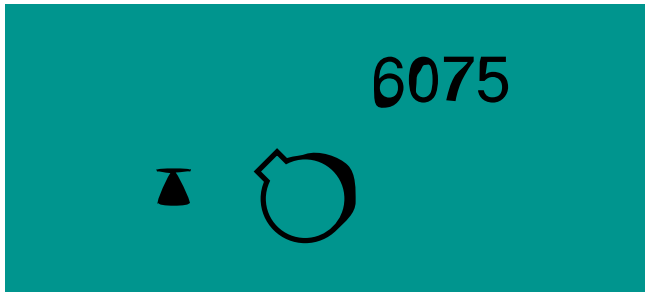

Acceptable – Class 1, 2, 3

- Characters are legible.
- Ink may be built up outside the character line providing the character is legible.
- Portion of component clocking symbol outline may be missing, providing the required clocking is clearly defined.
- Marking ink on component hole land does not extend into the part mounting hole, or reduce minimum annular ring.
- Marking ink is allowed in plated-through holes and via holes into which no component lead is soldered unless the procurement document requires that the holes be completely solder filled.
- No encroachment of marking ink on edge board printed contacts or test points.
- On surface mount lands with a pitch of 1.25 mm [0.04921 in] or greater, encroachment of marking ink is on one side of land only and does not exceed 0.05 mm [0.0020 in].
- On surface mount lands with a pitch less than 1.25 mm [0.04921 in], encroachment of marking ink is on one side of land only and does not exceed 0.025 mm [0.000984 in].

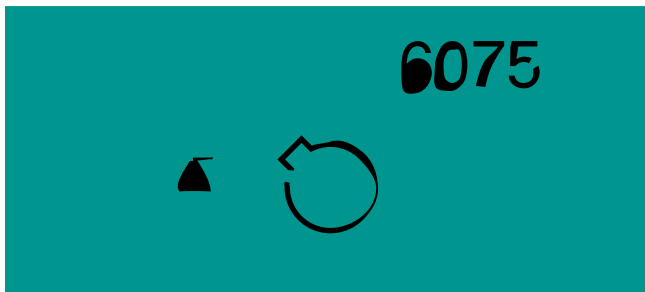

Acceptable – Class 1

- Marking may be smeared or blurred provided it is still legible.
- Double images are legible.



Nonconforming - Class 1, 2, 3

- Defects either do not meet or exceed above criteria.

2.9 SOLDER RESIST (Solder Mask)

Introduction

The term "Solder Resist" and "Solder Mask" are frequently used when referring to any type of permanent or temporary polymeric resist coating material. The term "solder resist" is used in this document as a general term when referring to any type of permanent polymer coating materials used on printed boards. Solder resists are used to limit and control the application of solder to selected areas of the printed board during assembly soldering operations. Solder resist coatings are used to control and limit surface contamination of printed board surfaces during soldering and subsequent processing operations, and are sometimes used to reduce dendritic filament growth(s) between conductive patterns over the printed board's base material surface. Detailed specifications and information regarding solder resist requirements are contained in IPC-6012 and IPC-SM-840.

Solder resist materials are not intended for use as a substitute for conformal coatings that are applied after assembly to cover components, component lead/terminations and solder connections. Determination of compatibility of solder resist materials with conformal coating materials, or other substances, is dependent upon the end item assembly environments.

The types of solder resist include:

- Deposited image, (liquid) screen printed form.
- Deposited image, electrostatic.
- Photo defined image, (liquid) resist form.
- Photo defined image, (dry film) resist form.
- Photo defined image, temporary resist.
- Photo defined, dry film over liquid.

Note: Touch up, if required to cover these areas with solder resist, **shall** be of a material that is compatible to and of equal resistance to soldering and cleaning as the originally applied resist.

2.9 SOLDER RESIST (Solder Mask)

2.9.1 Coverage Over Conductors (Skip Coverage)

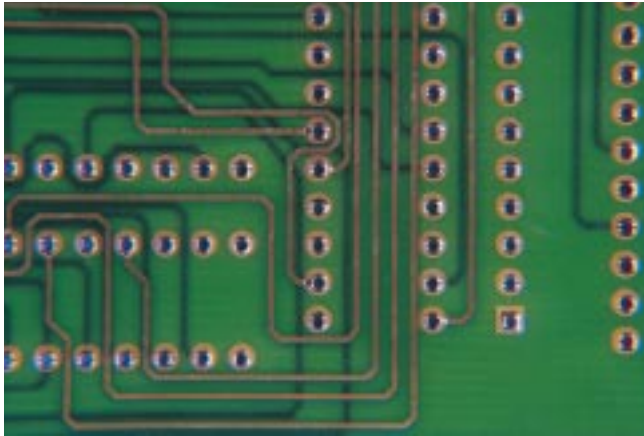

Target Condition – Class 1, 2, 3

- The solder resist exhibits uniform appearance over the base material surface, conductor sides and edges. It is firmly bonded to the printed board surface with no visible skipping, voids or other defects.



Acceptable – Class 2, 3

- In areas containing parallel conductors, adjacent conductors are not exposed by the absence of solder resist except where space between conductors is intended to be uncovered.
- Touch up, if required to cover these areas with solder resist, is of a material that is compatible to and of equal resistance to soldering and cleaning as the originally applied solder resist.

Acceptable - Class 1

- The missing solder resist does not reduce the conductor spacing between conductive patterns below the minimum acceptability requirements.
- There is skipping of the solder resist along the sides of the conductive patterns.

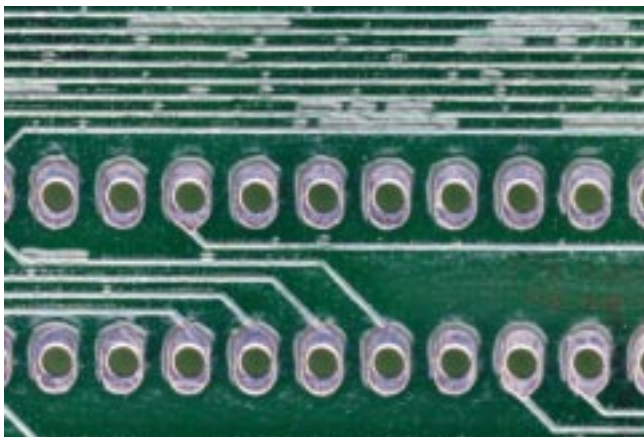

Nonconforming – Class 1, 2, 3

- Defects either do not meet or exceed above criteria.

2.9.2 Registration to Holes (All Finishes)

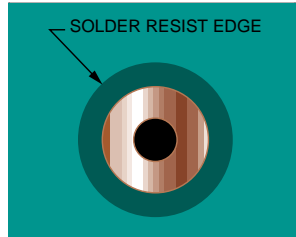
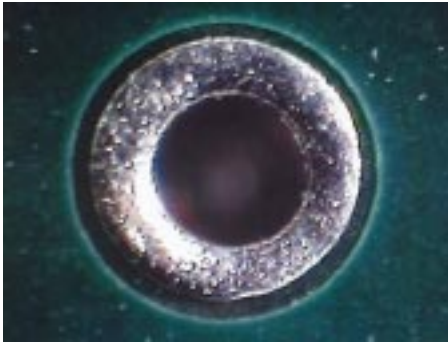

Target Condition – Class 1, 2, 3

- No solder resist misregistration. The solder resist is centered around the lands within the nominal registration spacings.

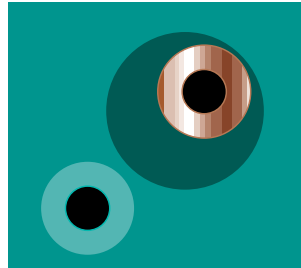
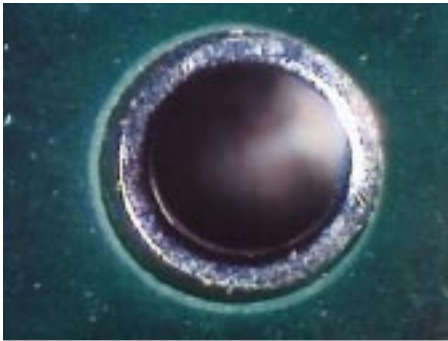

Acceptable – Class 1, 2, 3

- Misregistration of the resist to the land patterns but the resist does not violate minimum annular ring requirements.
- No solder resist in plated-through holes, except those not intended for soldering.
- Adjacent, electrically isolated lands or conductors are not exposed.

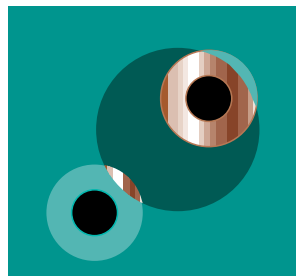
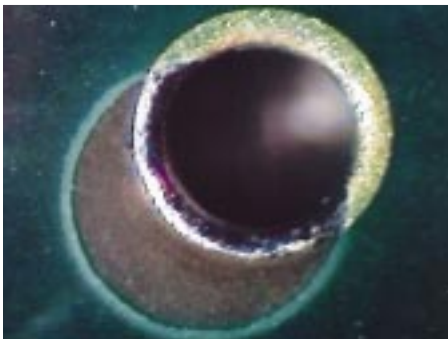

Nonconforming – Class 1, 2, 3

- Defects either do not meet or exceed above criteria.

2.9.3 Registration to Other Conductive Patterns

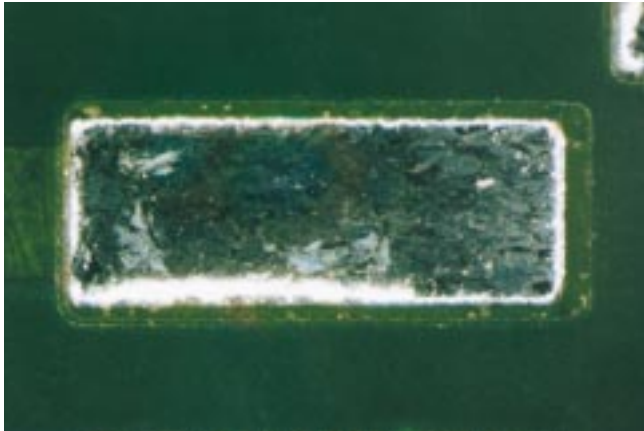

Target Condition – Class 1, 2, 3

- No solder resist misregistration.



Acceptable – Class 1, 2, 3

- Misregistration of solder resist defined lands does not expose adjacent, electrically isolated lands or conductors.
- No solder resist encroachment on edge board printed contacts or test points.
- On surface mount lands with a pitch of 1.25 mm [0.04921 in] or greater, encroachment is on one side of land only and does not exceed 0.05 mm [0.0020 in].
- On surface mount lands with a pitch less than 1.25 mm [0.04921 in], encroachment is on one side of land only and does not exceed 0.025 mm [0.000984 in].



Nonconforming – Class 1, 2, 3

- Defects either do not meet or exceed above criteria.

2.9 SOLDER RESIST (Solder Mask)

2.9.3.1 Ball Grid Array (Solder Resist-Defined Lands)

Solder Resist-Defined Lands: A portion of the conductive pattern, used to connect electronic component ball terminations, (BGAs, Fine-Pitch BGAs, etc.), where the solder resist encroaches on the edges of the land to restrict the ball attachment within the solder resist profile.



Target Condition – Class 1, 2, 3

- The solder resist overlap is centered around the lands.

Acceptable – Class 1, 2, 3

- Misregistration creates breakout of the solder resist on the land of not more than 90°.

Nonconforming - Class 1, 2, 3

- Defects either do not meet or exceed above criteria.

2.9 SOLDER RESIST (Solder Mask)

2.9.3.2 Ball Grid Array (Copper-Defined Lands)

Copper-Defined Lands: A portion of the conductive pattern usually, but not exclusively, used for the connection and/or attachment of components where the land metal is involved in the attachment process, and if solder resist is applied to the product a clearance is provided for the land area.

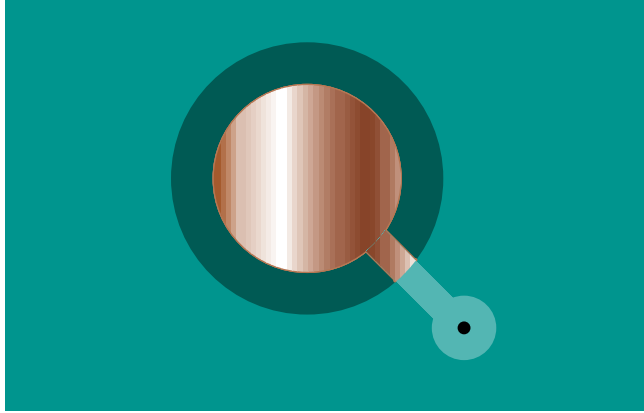

Target Condition

- The solder resist is centered around the copper land with clearance.

Acceptable - Class 1, 2, 3

- Solder resist does not encroach on the land, except at the conductor attachment.

Nonconforming - Class 1, 2, 3

- Defects either do not meet or exceed above criteria.

2.9 SOLDER RESIST (Solder Mask)

2.9.3.3 Ball Grid Array (Solder Dam)

Solder Dam: A portion of the solder resist pattern, used in conjunction with BGA or Fine Pitch BGA mounting, that provides a segment of solder resist material to separate the mounting portion of the pattern and the interconnection via in order to avoid solder being skived from the attachment joint into the via.

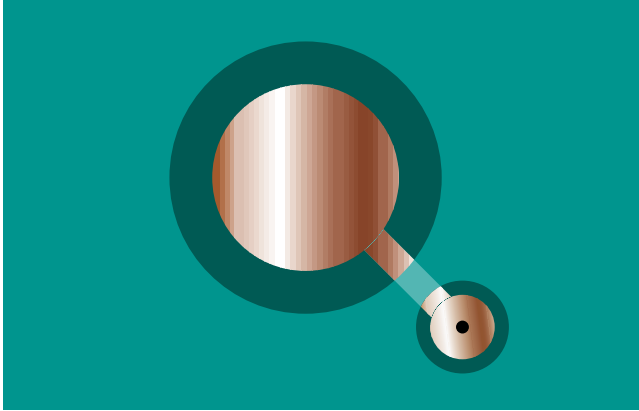

Target Condition

- The solder resist is centered around the copper land and escape via with clearance. Resist only covers the conductor between copper land and escape via.

Acceptable – Class 1, 2, 3

- If solder resist dam is specified (to prevent bridging of solder to the via), it remains in place with the copper covered.

Nonconforming - Class 1, 2, 3

- Defects either do not meet or exceed above criteria.

2.9 SOLDER RESIST (Solder Mask)

2.9.4 Blisters/Delamination

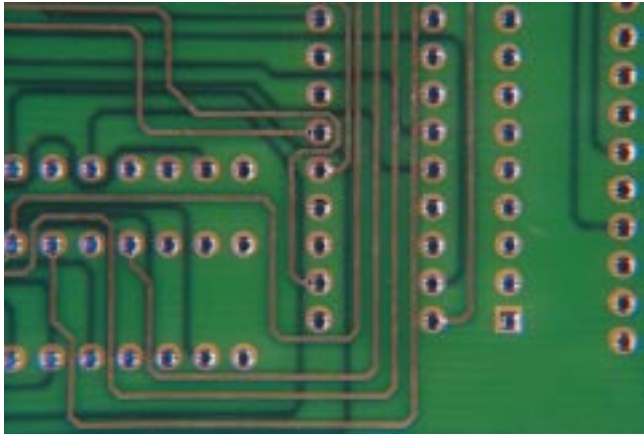

Target Condition – Class 1, 2, 3

- No evidence of blisters, bubbles or delamination between the solder resist and the printed board base material and conductive patterns.



Acceptable – Class 2, 3

- Two per side not exceeding 0.25 mm [0.00984 in] in the greatest dimension.
- Reduction of electrical spacing does not exceed 25%, or the minimum spacing.

Acceptable – Class 1

- Blisters, bubbles or delamination do not bridge between conductors.

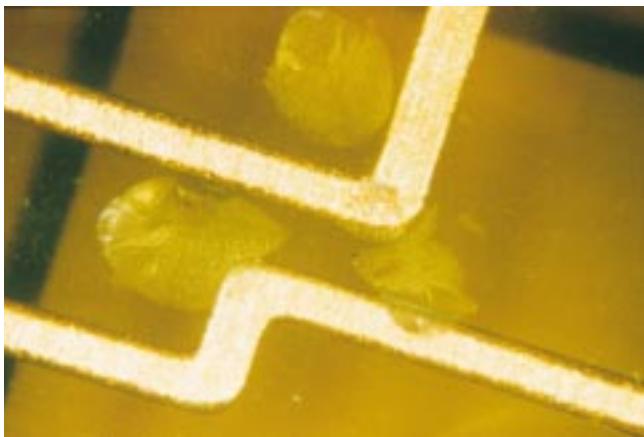

Nonconforming - Class 1, 2, 3

- Defects either do not meet or exceed above criteria.

2.9 SOLDER RESIST (Solder Mask)

2.9.5 Adhesion (Flaking or Peeling)

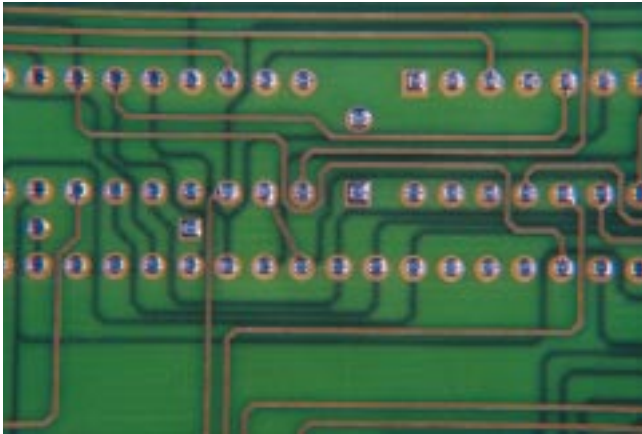

Target Condition – Class 1, 2, 3

- The surface of the solder resist is uniform in appearance and is firmly bonded to the printed board surfaces.

Acceptable – Class 2, 3

- No evidence of solder resist lifting from the board prior to testing.
- After testing in accordance with IPC-TM-650, Method 2.4.28.1, the amount of solder resist lifting does not exceed the allowable limits of the 6010 Series.

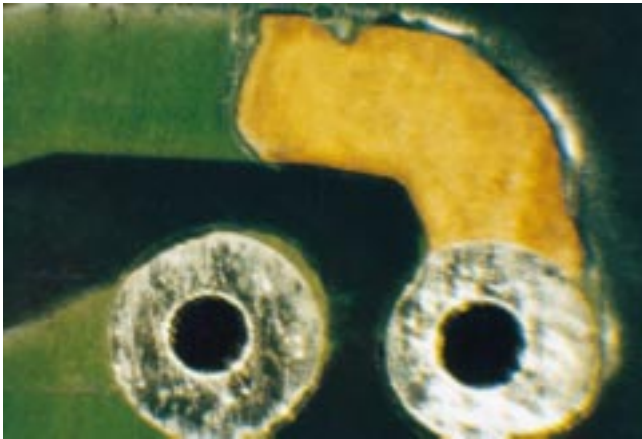

Acceptable – Class 1

- Prior to testing, the solder resist is flaking from the printed board base material or conductive pattern surfaces and the remaining solder resist is firmly bonded. The missing solder resist does not expose adjacent conductive patterns or exceed allowable lifting.
- After testing in accordance with IPC-TM-650, Method 2.4.28.1, the amount of solder resist lifting does not exceed the allowable limits of the IPC-6010 Series.



Nonconforming - Class 1, 2, 3

- Defects either do not meet or exceed above criteria.

2.9.6 Waves/Wrinkles/Ripples

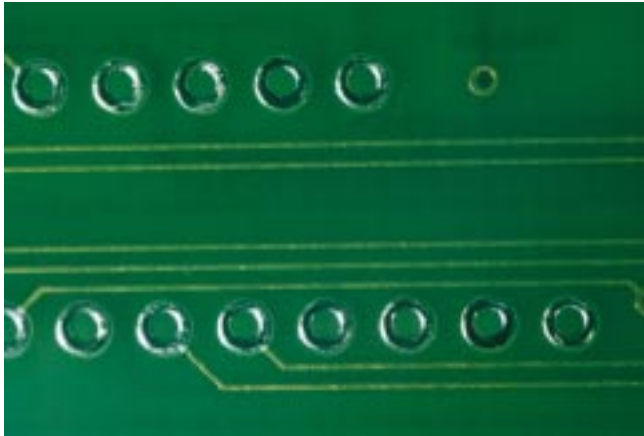

Target Condition – Class 1, 2, 3

- There are no wrinkles, waves, ripples or other defects in the solder resist coating over the printed board base material surfaces or conductive patterns.

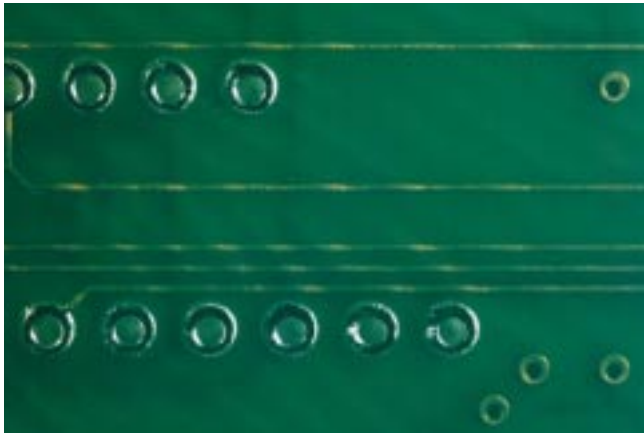

Acceptable – Class 1, 2, 3

- Waves or ripples in the solder resist do not reduce the solder resist coating thickness below the minimum thickness requirements (when specified).
- Minor wrinkling is located in an area that does not bridge conductive patterns and passes IPC-TM-650, Method 2.4.28.1 (adhesion tape pull test).



Nonconforming - Class 1, 2, 3

- Defects either do not meet or exceed above criteria.

2.9 SOLDER RESIST (Solder Mask)

2.9.7 Tenting (Via Holes)

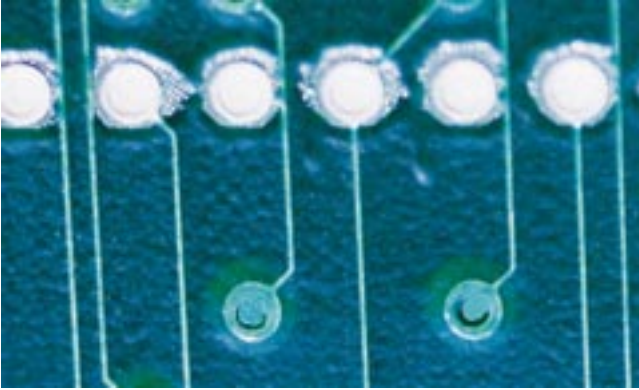

Target Condition – Class 1, 2, 3

- All holes required to be tented are completely covered with resist.

Acceptable – Class 1, 2, 3

- All holes required to be tented are covered by resist.

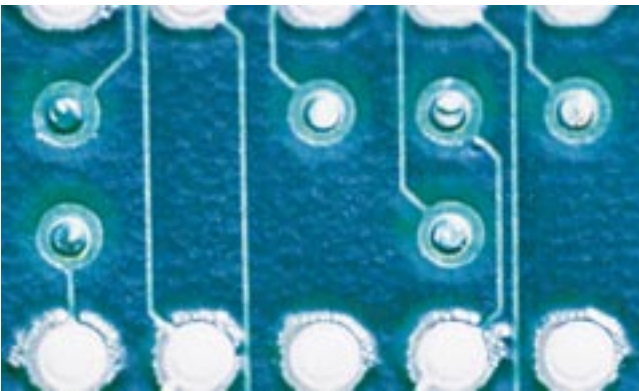

Nonconforming - Class 1, 2, 3

- Defects either do not meet or exceed above criteria.

2.9 SOLDER RESIST (Solder Mask)

2.9.8 Soda Strawing

Soda Strawing: A long tubular-like void along the edges of conductive patterns where the solder resist is not bonded to the base material surface or the edge of the conductor. Tin/lead fusing fluxes, fusing oils, solder fluxes, cleaning agents or volatile materials may be trapped in the soda straw void.



Target Condition – Class 1, 2, 3

- There are no visible soda straw voids between the solder resist and the printed board base material surface and the edges of the conductive patterns.

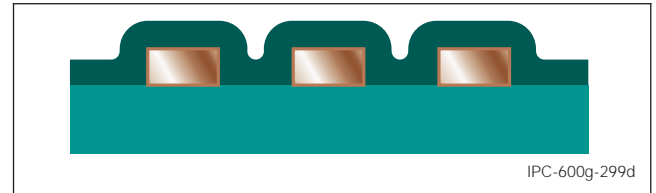

Acceptable – Class 3

- No evidence of soda strawing.



Acceptable – Class 1, 2

- Soda strawing along side conductive pattern edges does not reduce the conductor spacing below the minimum requirements.
- Soda strawing is completely sealed from the external environment.

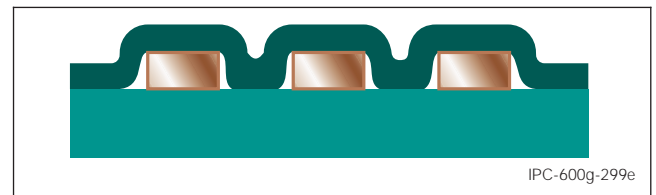

Nonconforming - Class 1, 2, 3

- Defects either do not meet or exceed above criteria.

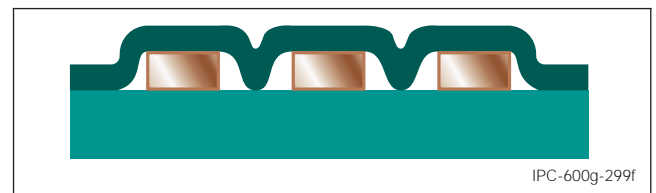

2.10 PATTERN DEFINITION – DIMENSIONAL

Introduction

Printed boards **shall** meet the dimensional requirements specified on the procurement documentation such as board periphery, thickness, cutouts, slots, notches and edge board contacts. The accuracy, repeatability and reproducibility of the equipment used to verify the characteristics of printed boards should be 10% or less of the tolerance range of the dimensions being verified.

2.10.1 Conductor Width and Spacing

This section covers acceptability requirements and criteria for conductor width and spacing. Acceptable conductor width and spacing is a measure of how well the printed board fabrication process is reproducing the master image, which basically determines the width and spacing requirements for the conductive patterns. Unless these characteristics are violated, edge definition itself is not necessarily a characteristic for acceptance or nonconformance, however, it can be considered a process indicator, requiring review of manufacturing procedures. In addition it may be an important consideration for controlled impedance circuits. Procurement documentation should establish edge definition requirements for applications of these types. When required, measurements of conductor edge definition are made in accordance with IPC-TM-650, Method 2.2.2.

2.10 PATTERN DEFINITION – DIMENSIONAL

2.10.1.1 Conductor Width



Target Condition – Class 1, 2, 3

- Conductor widths and spacing meet dimensional requirements of artwork or procurement documentation.

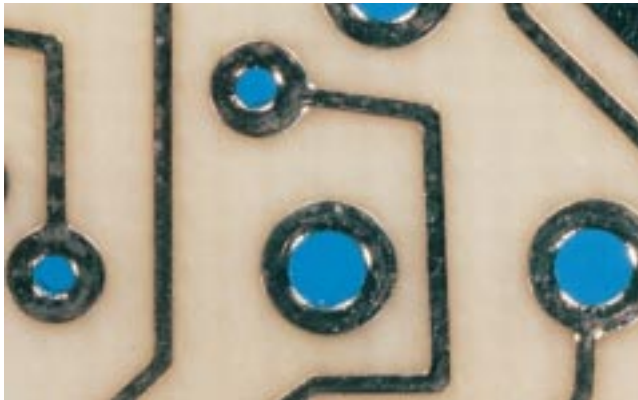

Acceptable – Class 2, 3

- Any combination of isolated edge roughness, nicks, pinholes, and scratches exposing base material that reduces the conductor width by 20% of the minimum value or less.
- There is no occurrence (edge roughness, nicks, etc.) greater than 10% of the conductor length or more than 13 mm [0.512 in], whichever is less.



Acceptable – Class 1

- Any combination of isolated edge roughness, nicks, pinholes, and scratches exposing base material that reduces the conductor width 30% of the minimum value or less.
- There is no occurrence (edge roughness, nicks, etc.) greater than 10% of the conductor length or more than 25 mm [0.984 in], whichever is less.

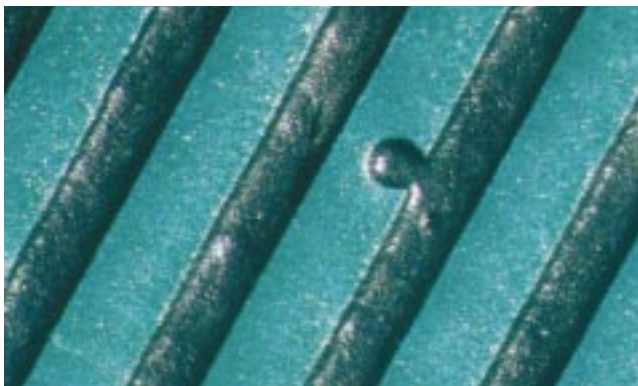

Nonconforming - Class 1, 2, 3

- Defects either do not meet or exceed above criteria.

2.10 PATTERN DEFINITION – DIMENSIONAL

2.10.1.2 Conductor Spacing

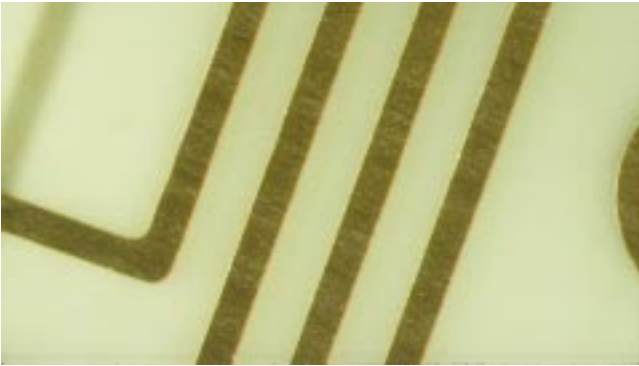

Target Condition – Class 1, 2, 3

- Conductor spacing meets dimensional requirements of the procurement documentation.

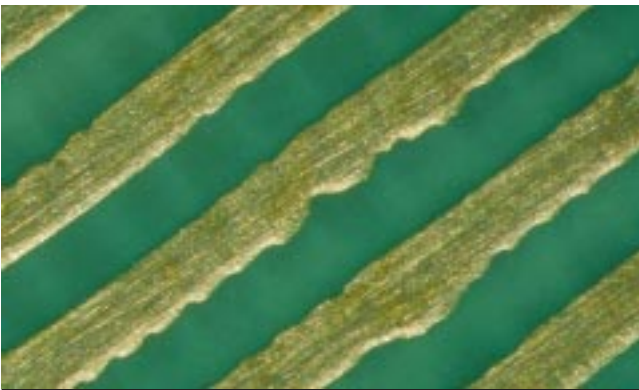

Acceptable – Class 3

- Any combination of edge roughness, copper spikes, etc., that does not reduce the specified minimum conductor spacing by more than 20% in isolated areas.

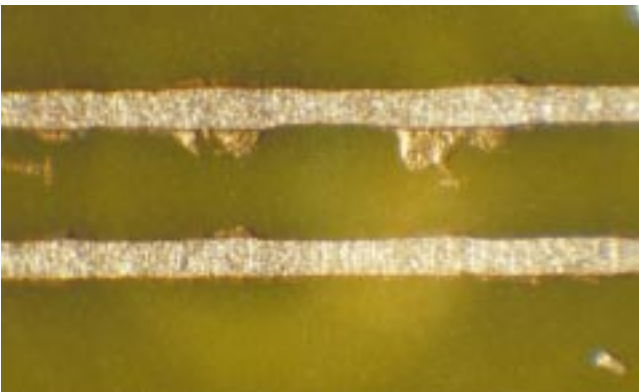

Acceptable – Class 1, 2

- Any combination of edge roughness, copper spikes, etc., that does not reduce the specified minimum conductor spacing by more than 30% in isolated areas.



Nonconforming - Class 1, 2, 3

- Defects either do not meet or exceed above criteria.

2.10.2 External Annular Ring – Measurement

Annular Ring: The minimum annular ring on external layers is the minimum amount of copper (at the narrowest point) between the edge of the hole and the edge of the land after plating of the finished hole (see Figure 1). The minimum annular ring on internal layers is the minimum amount of copper (at the narrowest point) between the edge of the drilled hole and the edge of the land after drilling the hole (see Figure 2).

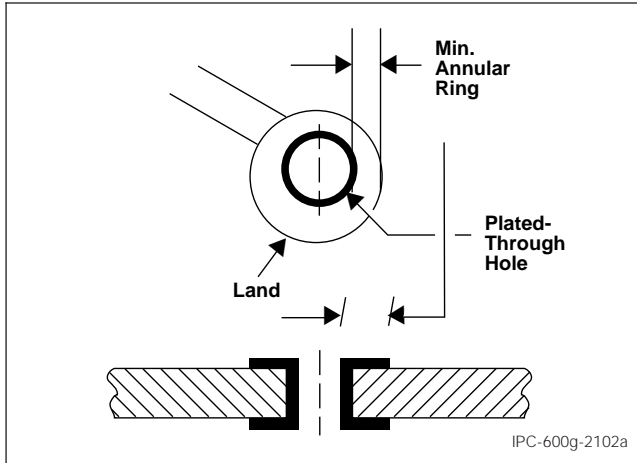

Figure 1 External Annular Ring

Conductor to Land Junction: A 90° area centered around the point where the conductor connects to the land (see Figure 3). This area only applies to breakout conditions.

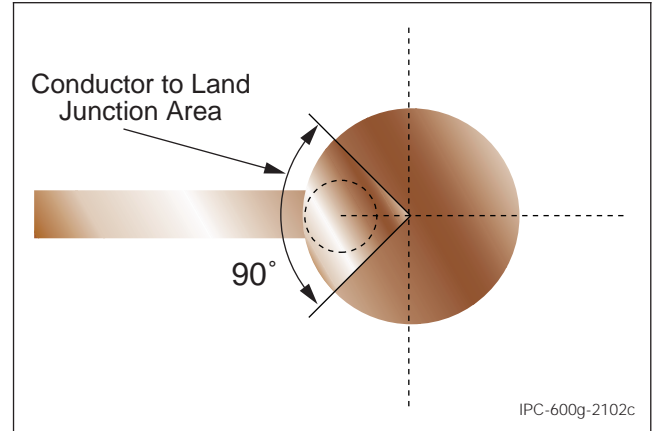

Figure 3 Conductor to Land Junction

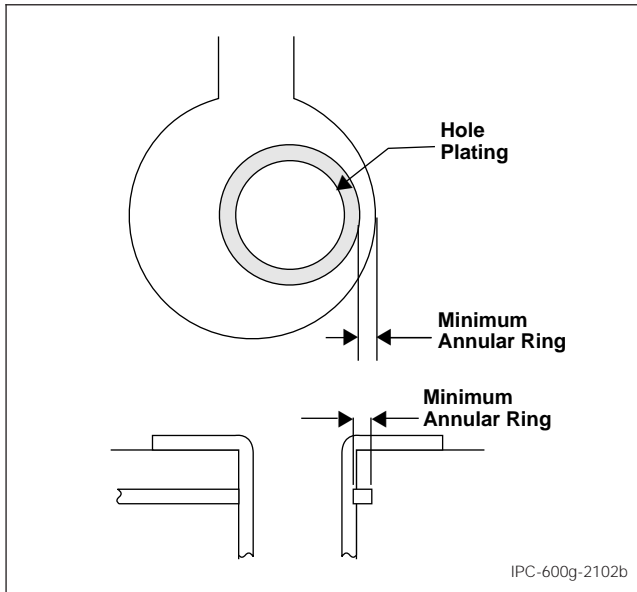
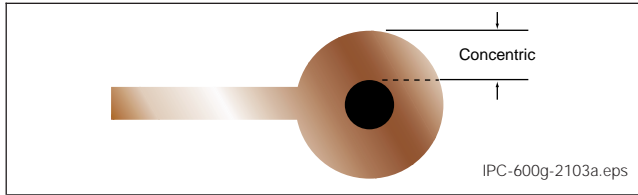

Figure 2 Internal Annular Ring

2.10 PATTERN DEFINITION – DIMENSIONAL

2.10.3 External Annular Ring - Supported Holes



Target Condition – Class 1, 2, 3

- Holes are centered in the lands.

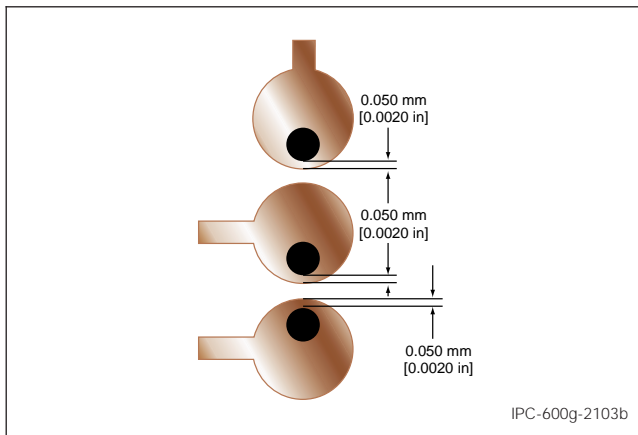

Acceptable – Class 3

- Holes are not centered in the lands, but the annular ring measures 0.050 mm [0.0020 in] or more.
- The minimum external annular ring may have 20% reduction of the minimum annular ring at the measurement area due to defects such as pits, dents, nicks, pinholes, or splay.

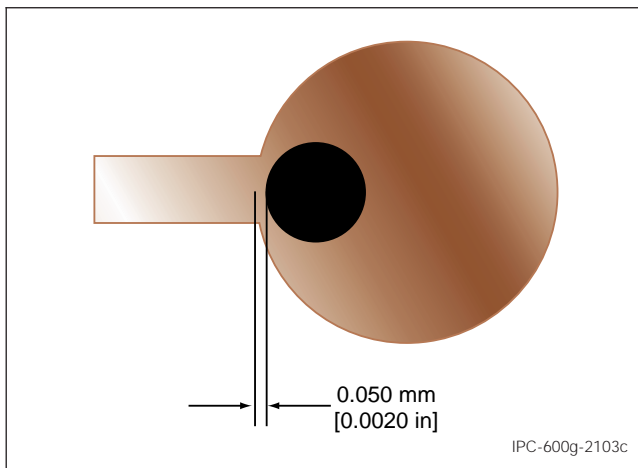

Acceptable – Class 2

- 90° breakout or less. (A)
- If breakout occurs at the conductor to land junction area, the conductor is not reduced by more than 20% of the minimum conductor width specified on the engineering drawing or the production master nominal. The conductor junction should never be less than 0.050 mm [0.0020 in] or the minimum line width, whichever is smaller. (C)
- Minimum lateral spacing between conductors is maintained.

Acceptable – Class 1

- 180° breakout or less. (B)
- If breakout occurs at the conductor to land junction area, the conductor is not reduced by more than 30% of the minimum conductor width specified on the production master nominal. (D)
- Form, fit and function are not affected.
- Minimum lateral spacing between conductors is maintained.

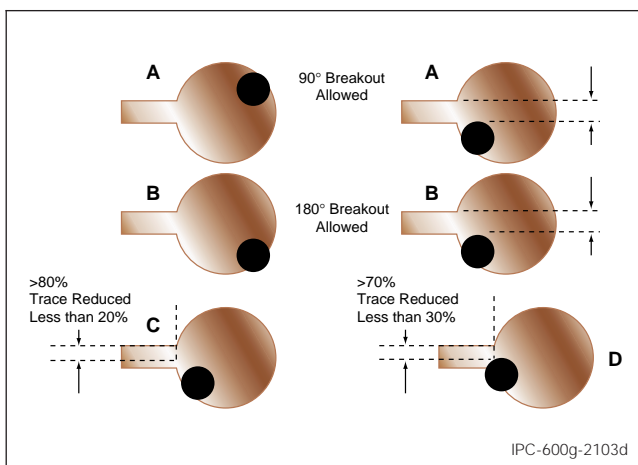

Nonconforming - Class 1, 2, 3

- Defects either do not meet or exceed above criteria.

2.10.4 External Annular Ring – Unsupported Holes

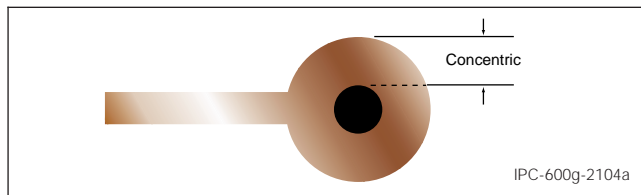

Target Condition – Class 1, 2, 3

- Holes are centered in the lands.

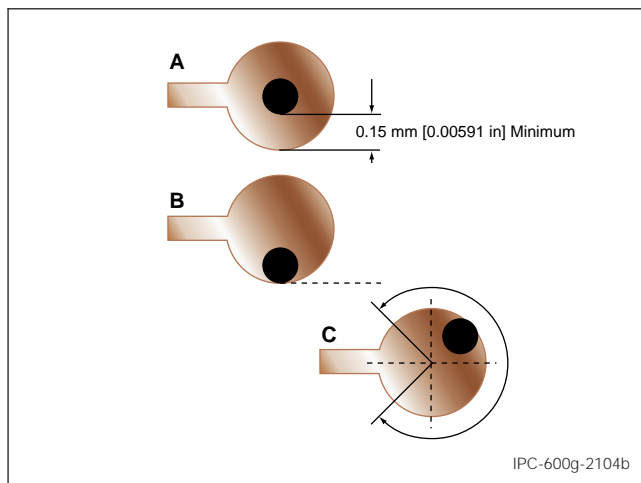

Acceptable – Class 3

- Annular ring measures 0.15 mm [0.00591 in] or more in any direction. (A) The minimum external annular ring may have a 20% reduction of the minimum annular ring at the measurement area due to defects such as pits, dents, nicks, pin-holes or splay.

Acceptable – Class 2

- 90° breakout is allowed. (B)
- If breakout occurs at the conductor to land junction area, the conductor is not reduced by more than 20% of the minimum conductor width specified on the engineering drawing or the production master nominal.

Acceptable – Class 1

- 90° breakout is allowed. (C)
- If breakout occurs at the conductor to land junction area, the conductor is not reduced by more than 30% of the minimum conductor width specified on the production master nominal.

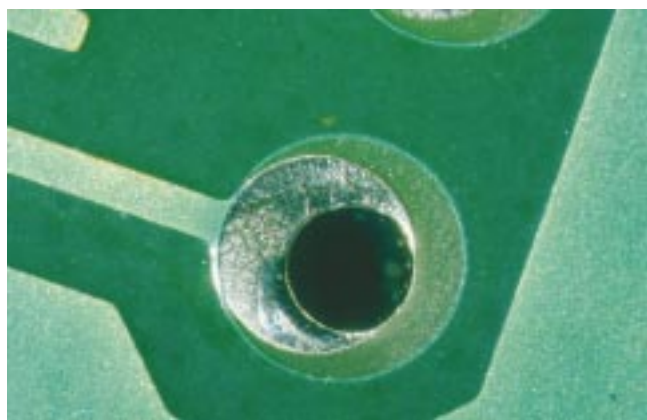

Nonconforming - Class 1, 2, 3

- Defects either do not meet or exceed above criteria.

2.11 FLATNESS

Introduction

Flatness of printed boards is determined by two characteristics of the product; these are known as bow and twist. The bow condition is characterized by a roughly cylindrical or spherical curvature of the board while its four corners are in the same plane. Twist is the board deformation parallel to the diagonal of the board such that one corner is not in the same plane to the other three. Circular or elliptical boards must be evaluated at the highest point of vertical displacement. Bow and twist may be influenced by the board design as different circuit configurations or layer construction of multilayer printed boards can result in different stress or stress relief conditions. Board thickness and material properties are other factors that influence the resulting board flatness.

Bow and Twist Bow, twist, or any combination thereof, **shall** be determined by physical measurement and percentage calculation in accordance with IPC-TM-650, Method 2.4.22. Panels containing multiple boards that are assembled in panel form and later separated **shall** be assessed in panel form.

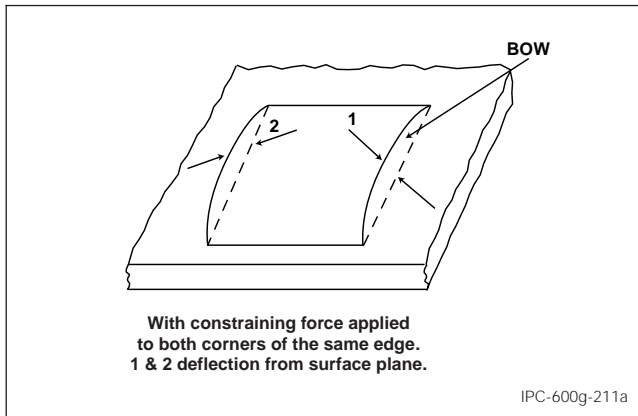

Acceptable - Class 1, 2, 3

- For printed boards using surface mount components, the bow and twist **shall** be 0.75% or less.
- For all other boards, bow and twist **shall** be 1.50% or less.

Nonconforming - Class 1, 2, 3

- Defects either do not meet or exceed above criteria.

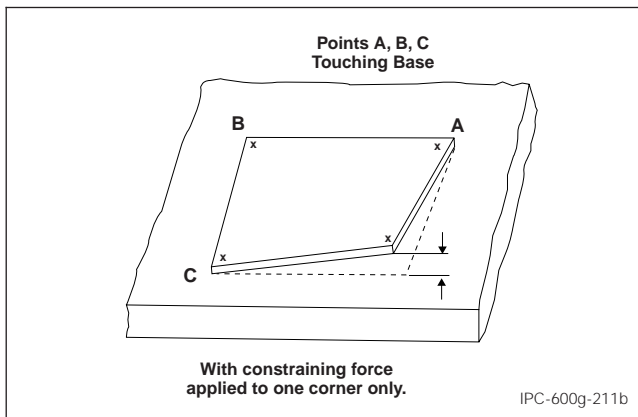

3.0 INTERNALLY OBSERVABLE CHARACTERISTICS

Introduction

The purpose of this section is to provide acceptability requirements for those characteristics which are internal to the printed board. These include the following characteristics in the base material, plated-through holes, internal conductive copper pattern, treatments to the internal copper, and internal ground/power/thermal planes, as described below:

- Subsurface imperfections in board material, such as delamination, blistering, and foreign inclusions.
- Subsurface imperfections to multilayer printed boards, such as voids, delamination, blistering, cracks, ground plane clearance and layer to layer spacing.
- Plated-through hole anomalies, including size, annular ring, nailheading, plating thickness, plating voids, nodules, cracks, resin smear, inadequate or excessive etchback, wicking, inner layer (post) separation, and solder resist thickness.
- Internal conductor anomalies, such as over or under etch, conductor cracks and voids, uneven or inadequate oxide treatment, and foil thickness.
- Visual observations made on cross-sections only.

3.1 DIELECTRIC MATERIALS

Introduction

This section covers the acceptability requirements of dielectric materials. Dielectric materials are evaluated after thermal stress. Requirements for evaluations made in the as received condition should be stated on the procurement documentation.

3.1.1 Laminate Voids (Outside Thermal Zone)

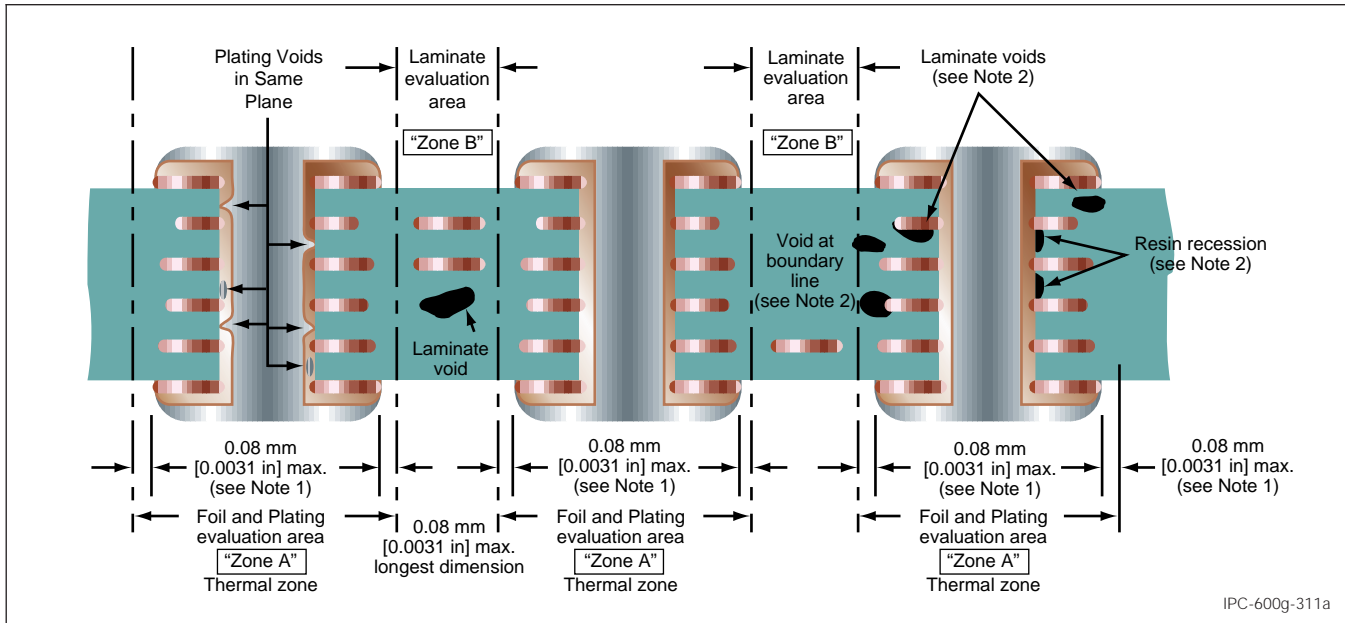

Notes:

1. The thermal zone extends 0.08 mm [0.0031 in] beyond the end of the land, either internal or external, extending furthest into the laminate area.
2. Laminate anomalies or imperfections in the Zone A areas are not evaluated on specimens which have been exposed to thermal stress or rework simulation.
3. Delamination/Blistering is evaluated in both Zone A and Zone B.

Visual observations made on cross-sections only.

3.1 DIELECTRIC MATERIAL

3.1.1 Laminate Voids (Outside Thermal Zone) (cont.)



Target Condition

- Uniform and homogeneous laminate.



Acceptable – Class 2, 3

- Void less than or equal to 0.08 mm [0.0031 in] and does not violate minimum dielectric spacing.
- Laminate anomalies or imperfections, such as voids or resin recession, in Zone A areas that have been exposed to thermal stress and rework simulation.
- Multiple voids between two adjacent plated-through holes in the same plane **shall not** have combined length which exceeds these limits.

Acceptable – Class 1

- Void less than or equal to 0.15 mm [0.00591 in] and does not violate minimum dielectric spacing.
- Laminate anomalies or imperfections, such as voids or resin recession, in Zone A areas that have been exposed to thermal stress and rework simulation.
- Multiple voids between two adjacent plated-through holes in the same plane **shall not** have combined length which exceeds these limits.

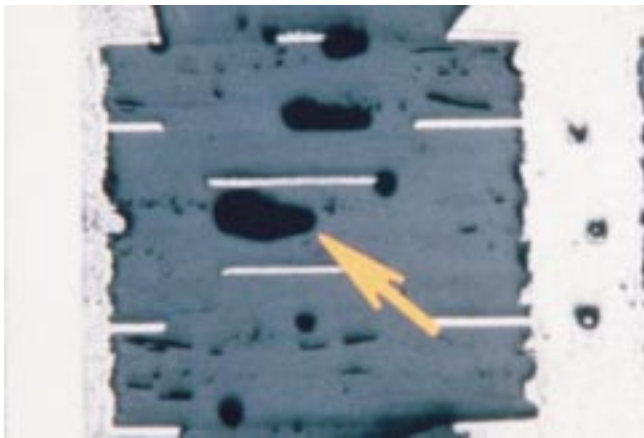

Nonconforming - Class 1, 2, 3

- Defects either do not meet or exceed above criteria.

Visual observations made on cross-sections only.

3.1 DIELECTRIC MATERIAL

3.1.2 Registration/Conductors to Holes

Registration of conductors is typically determined with respect to plated-through hole lands.

Requirements are established through minimum internal annular ring (see 3.3.1).

Visual observations made on cross-sections only.

3.1 DIELECTRIC MATERIAL

3.1.3 Clearance Hole, Unsupported, to Power/Ground Planes

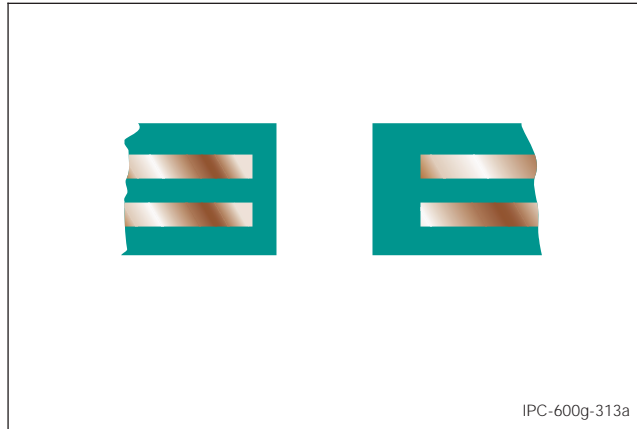

Target Condition – Class 1, 2, 3

- Power/Ground plane setback meets the procurement documentation requirements.

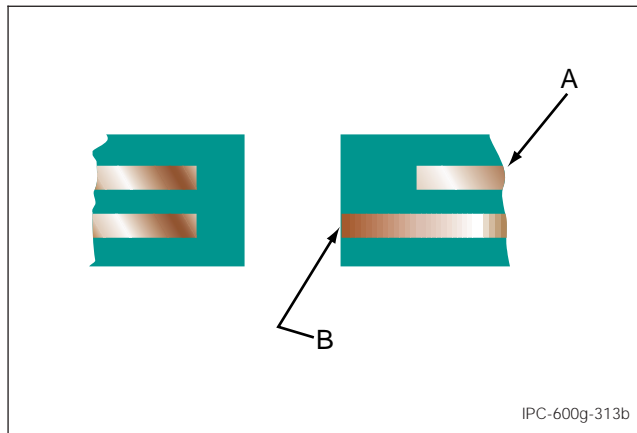

Acceptable – Class 1, 2, 3

- A) Power/ground plane setback is greater than the minimum electrical conductor spacing specified on the procurement documentation.
- B) Ground plane may extend to the edge of an unsupported hole when specified in the procurement documentation.

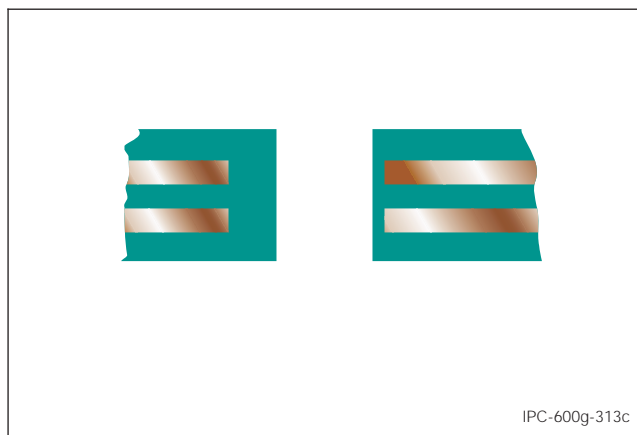

Nonconforming - Class 1, 2, 3

- Defects either do not meet or exceed above criteria.

Visual observations made on cross-sections only.

3.1 DIELECTRIC MATERIAL

3.1.4 Delamination/Blister



Target Condition – Class 1, 2, 3

- No delamination or blistering.

Acceptable – Class 2, 3

- No evidence of delamination or blistering.

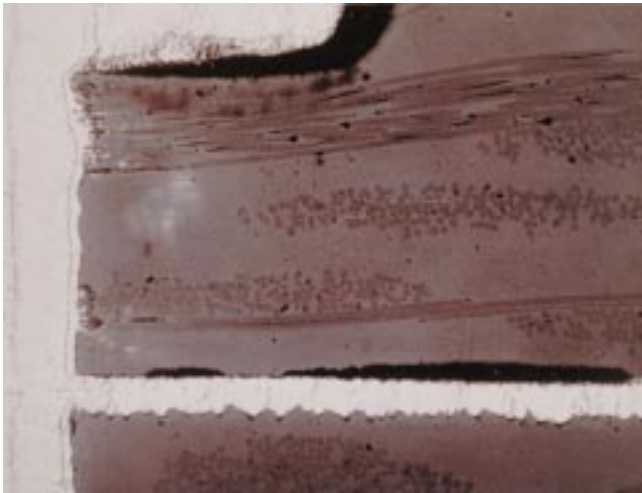

Acceptable – Class 1

- If delamination or blistering is present, evaluate the entire board with the requirement of 2.3.3.

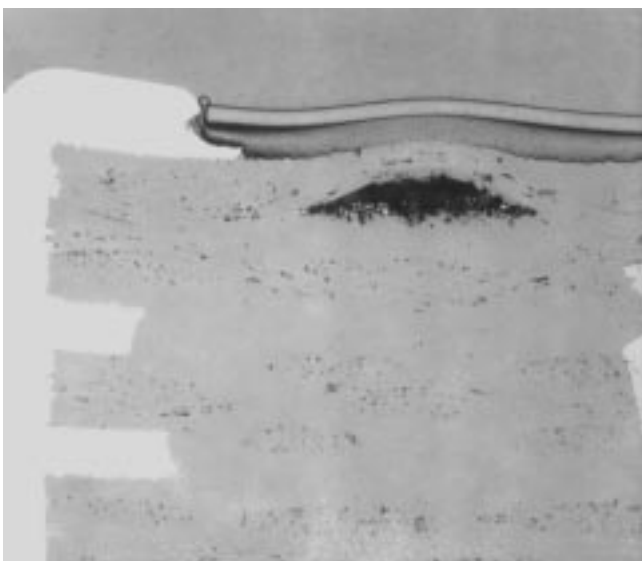

Nonconforming - Class 1, 2, 3

- Defects either do not meet or exceed above criteria.

Visual observations made on cross-sections only.

3.1 DIELECTRIC MATERIAL

3.1.5 Etchback

Acceptable etchback or negative etchback, exhibits the evidence that resin smear has been removed from the innerlayer copper/drilled hole interface. An example of resin smear appears in Figure 1. There is data, pro and against, that etchback is more reliable than negative etchback and vice versa. This all depends on what type of copper plating, copper foil, and weight of the foil being used. Excessive etchback as well as excessive negative etchback are not the target condition. Excessive etchback, in both instances, has an adverse effect on the reliability of the plated-through hole life.

Etchback: The etchback process, also known as positive etchback, is used to remove the dielectric material. The evidence of resin material being etched back theorizes that all resin smear has been removed and in addition, a three way interfacial bond occurs between the plated hole copper to the innerlayer copper foil. Theory is that three connections are more reliable than one. The drawbacks of etchback are that it creates rough holes which could create plated-through hole barrel cracks. Excessive etchback also contributes to stresses that might create foil cracks. Shadowing is defined as a condition that occurs during an etchback process in which the dielectric material immediately next to the foil is not removed completely. This can occur even though an acceptable amount of etchback may have been achieved elsewhere.

Negative Etchback: The theory here is that in order for the internal foil to be etched back/cleaned, you need to eliminate the smear. The benefits for utilizing negative etchback are that the process does not create a stress point at the internal plane, as does the etchback process, and it results in a very smooth/uniform copper barrel hole wall. The smooth hole wall and negative etchback are beneficial especially for the copper plating of high-reliability long term life applications. The drawback of negative etchback, if excessive, is that it may create innerlayer separation due to entrapped air pockets/contamination.

This section is not intended to prove or disprove which etchback process is preferred. There are many board manufacturers that are very successful in utilizing both the etchback and negative etchback processes. It is up to the individual designer/user, depending on the material, copper plating, copper foil and application, to specify what etchback process should be employed.

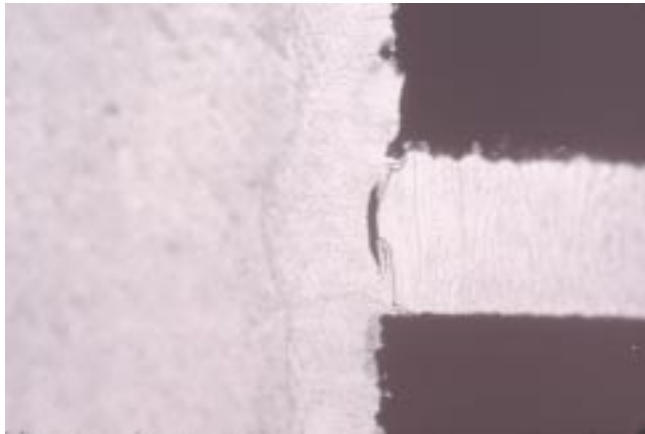
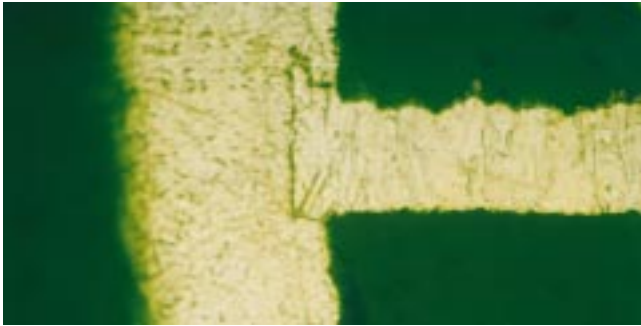

Figure 1 An example of resin smear prior to removal by etchback

Visual observations made on cross-sections only.

3.1 DIELECTRIC MATERIAL

3.1.5.1 Etchback



Target Condition – Class 1, 2, 3

- Uniform etchback to a preferred depth of 0.013 mm [0.000512 in].

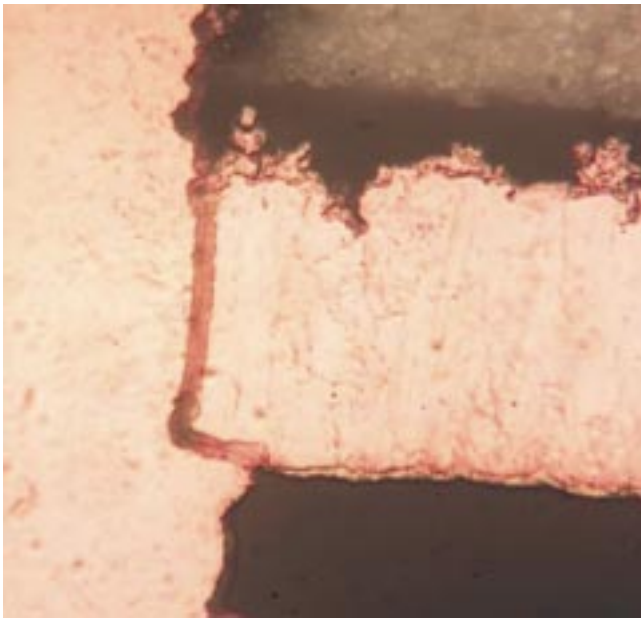

Acceptable – Class 1, 2, 3

- Etchback between 0.005 mm [0.00020 in] and 0.08 mm [0.0031 in].
- Shadowing is permitted on one side of each land.

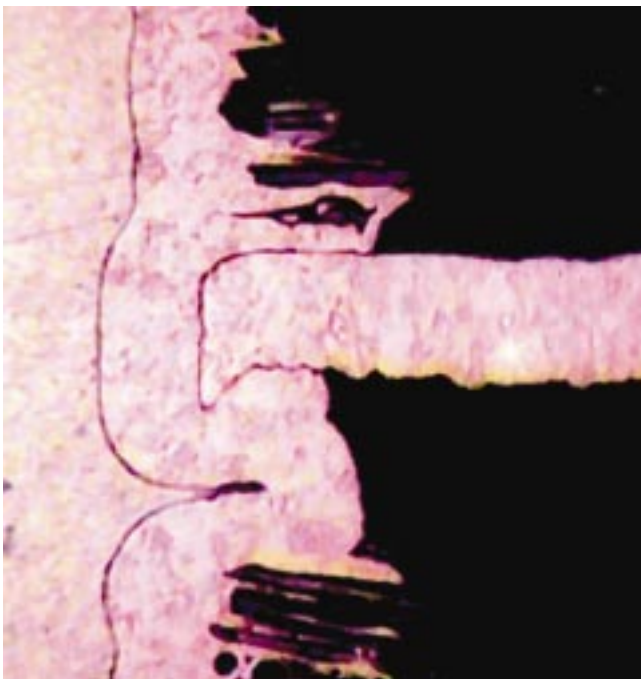

Nonconforming - Class 1, 2, 3

- Defects either do not meet or exceed above criteria.

Visual observations made on cross-sections only.

3.1 DIELECTRIC MATERIAL

3.1.5.2 Negative Etchback

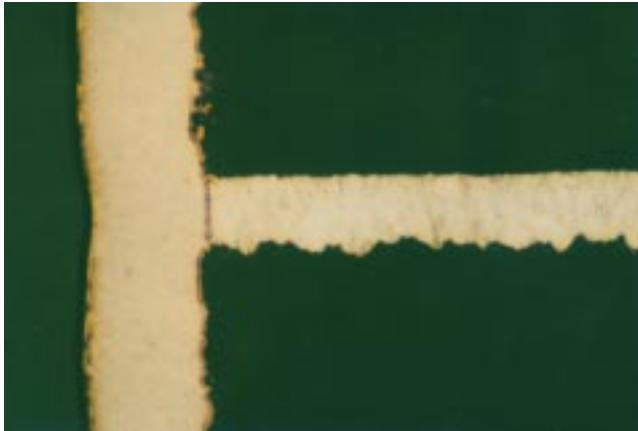

Target Condition – Class 1, 2, 3

- Uniform negative etchback of copper foil 0.0025 mm [0.0000984 in].

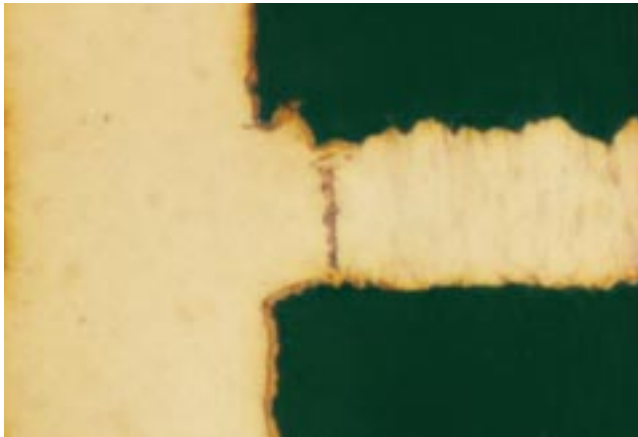

Acceptable – Class 3

- Negative etchback less than 0.013 mm [0.000512 in].

Acceptable – Class 1, 2

- Negative etchback less than 0.025 mm [0.000984 in].



Nonconforming - Class 1, 2, 3

- Defects either do not meet or exceed above criteria.

Visual observations made on cross-sections only.

3.1 DIELECTRIC MATERIAL

3.1.6 Smear Removal

Smear removal is defined as the removal of resins debris which results from the formation of the hole.

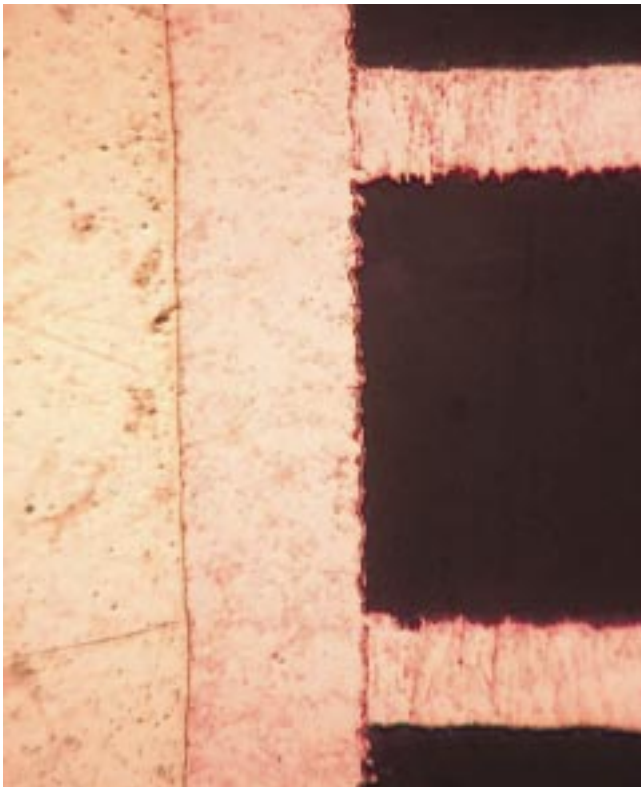

Acceptable - Class 1, 2, 3

- Smear removal has not been etched back greater than 0.025 mm [0.001 in].
- Random tears or drill gouges producing small areas where the 0.025 mm [0.001 in] depth has been exceeded **shall** be evaluated as etchback per 3.1.5.1.
- Smear removal sufficiently meets the acceptability criteria for plating separation (3.3.13).

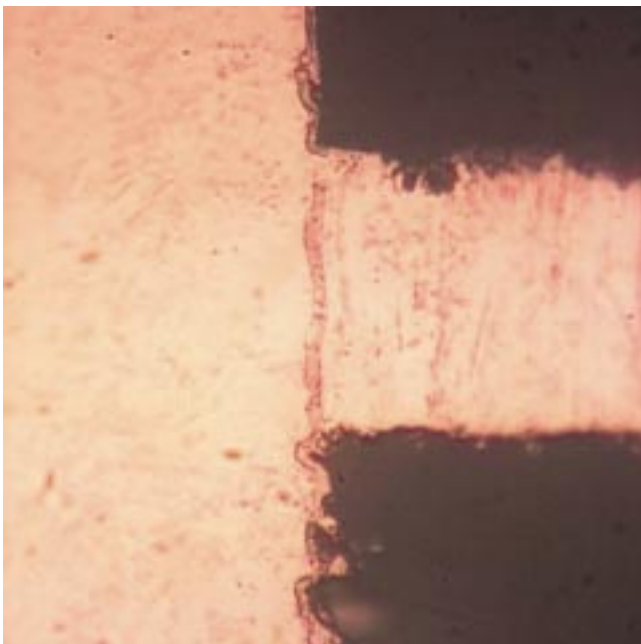

Nonconforming - Class 1, 2, 3

- Defects either do not meet or exceed above criteria.

Visual observations made on cross-sections only.

3.1 DIELECTRIC MATERIAL

3.1.7 Dielectric Material, Clearance, Metal Plane for Supported Holes

Metal planes are used for mechanical reinforcement and/or electromagnetic shielding for printed boards. Many requirements are the same as for metal-core printed boards.

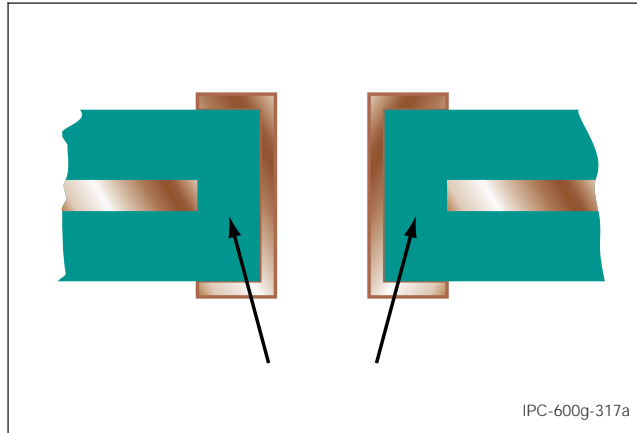

Target Condition – Class 1, 2, 3

- Metal plane setback exceeds the procurement documentation requirements.

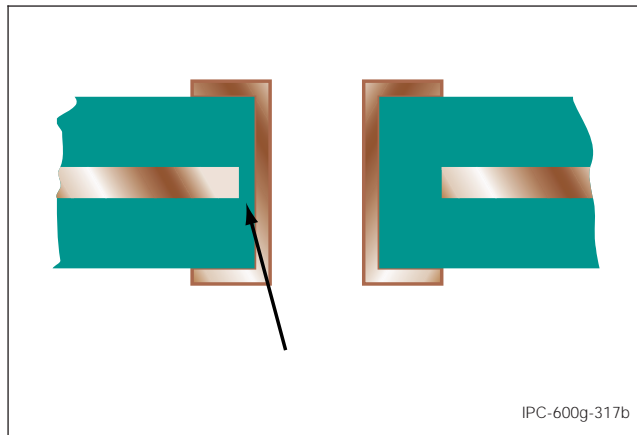

Acceptable – Class 1, 2, 3

- Metal plane setback is equal to or greater than 0.1 mm [0.0040 in] (when a value is not specified by the procurement documentation).
- Metal plane setback does not reduce the conductor spacing to less than specified minimum on the procurement documentation.

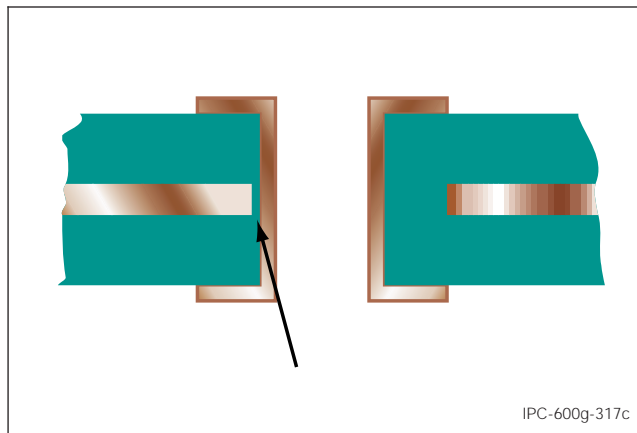

Nonconforming - Class 1, 2, 3

- Defects either do not meet or exceed above criteria.

Visual observations made on cross-sections only.

3.1 DIELECTRIC MATERIAL

3.1.8 Layer-to-Layer Spacing

Minimum dielectric thickness is the maximum material condition used for the electrical voltage dielectric strength requirements.

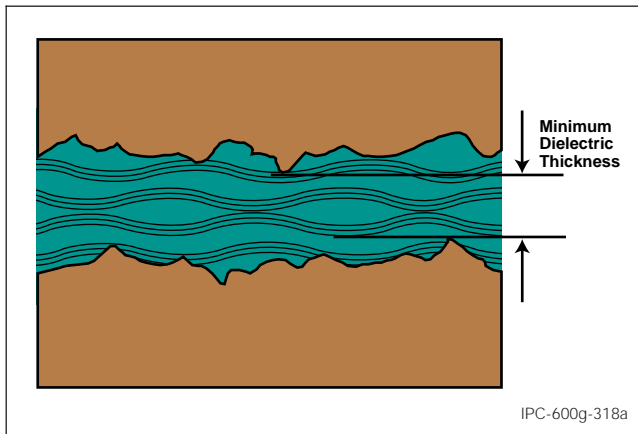

Target Condition – Class 1, 2, 3

- The minimum dielectric thickness meets the requirements of the procurement documentation.

Acceptable – Class 1, 2, 3

- The minimum dielectric thickness meets the minimum requirements of the procurement documentation. If not specified, must be 0.09 mm [0.0035 in] or greater.

Nonconforming - Class 1, 2, 3

- Defects either do not meet or exceed above criteria.

Notes

- 1: Products designed for transmission line impedance applications may have special requirements and measurement method specified on procurement documentation.
- 2: When the nominal dielectric thickness on the drawing is less than 90.0 μm [3543 μin], the minimum dielectric spacing is 25.0 μm [984 μin] and the number of reinforcing layers may be selected by the supplier.

Visual observations made on cross-sections only.

3.1 DIELECTRIC MATERIAL

3.1.9 Resin Recession

Resin recession in a plated-through hole is generally defined as a separation between the plated barrel of the hole and the dielectric material on the hole wall. It is acceptable for all classes after thermal stress testing, unless otherwise specified on the procurement documentation.



Acceptable - Class 1, 2, 3

- Resin recession is acceptable following thermal stress testing.

Visual observations made on cross-sections only.

3.2 CONDUCTIVE PATTERNS – GENERAL

Introduction

This section covers acceptability requirements for printed board etching, innerlayers, and impedance controlled products. An acceptable etching process must result in all residual metal being removed with no evidence of contamination remaining on the product.

Over etching is cause for rejection when potential slivers result from excessive overhang of metal resist plating or when the finished conductor widths are less than specification requirements.

Under etching is cause for rejection when spurious metal remains on the product to the extent that spacing between conductors is less than specification requirements or if conductor width requirements are exceeded.

Conductor width is defined as the observable width of the copper conductor excluding organic or metallic resists unless otherwise specified. The "Minimum Conductor Width" often specified on the procurement documentation or performance document is usually measured at the base of the conductor and may not be the actual narrowest width of the conductor when observed in cross-section or often when viewed from the surface. An observation from the surface may not be adequate for acceptance of some products and etching processes. Where resistance per unit length is a requirement, a measurement of the average width of the cross-sectional area may be necessary. Where impedance control is required, a determination of the maximum conductor width may be important for the calculating impedance and a cross-section is often required.

Considerable variation in etch configurations is possible due to different etchants, resists and plated metal thicknesses. The conductor width may increase or decrease from the production artwork due to techniques used in processing during the imaging and developing operations. To achieve the "Design Width of Conductor," the production master artwork often has conductor width adjustments made during plotting. The amount of adjustment of a conductor width on the "Production Master" may be 0.025 mm to 0.05 mm [0.000984 in to 0.0020 in]. Determination of adjustment is made by experimentation and compensation for an increase or decrease of the conductor width during plating or etching.

The illustrations in 3.2.1 are intended as a guideline to illustrate some of the edge geometry conditions which may result from different processing methods and illustrate the configurations of "Outgrowth," "Undercut" and "Overhang."

Definitions used in evaluating etched conditions (see IPC-T-50):

Outgrowth: The increase in conductor width at one side of the conductor, caused by plating buildup over that delineated by the production master.

Undercut: The distance on one edge of the conductor measured parallel to the board surface from the outer edge of the conductor, including etch resists, to the maximum point indentation to the copper conductor.

Overhang: The sum of the outgrowth and undercut.

Design width of conductor: The width of a conductor as delineated or noted on the procurement documentation.

Notes: 1. The "Production Master" may be adjusted for process methods and the artwork conductor width may differ from the design width.
2. Design width of conductor is most often stated as a minimum as measured at the base of the conductor. For impedance controlled circuits, a \pm tolerance may be placed on conductor width.

Production Master: A 1 to 1 scale pattern which is used to produce one or more printed boards within the accuracy specified on the Procurement Documentation.

Etch Factor: The ratio of the depth of etch to the amount of lateral etch.

Visual observations made on cross-sections only.

3.2 CONDUCTIVE PATTERNS – GENERAL

3.2.1 Etching Characteristics

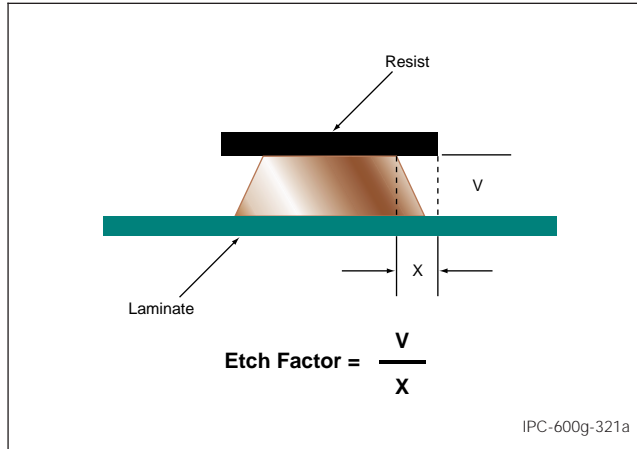

"A" Point of Narrowest Conductor Width: This is not "Minimum Conductor Width" noted on procurement documentation or performance specifications.

"B" Conductor Base Width: The width that is measured when "Minimum Conductor Width" is noted on the procurement documentation or performance specification.

"C" Production Master Width: This width usually determines the width of the metal or organic resist on the etched conductor.

Design width of the conductor is specified on the procurement documentation and is most often measured at the conductor base "B" for compliance to "Minimum Conductor Width" requirements.

The following two configurations show that conductor width may be greater at the surface than at the base.

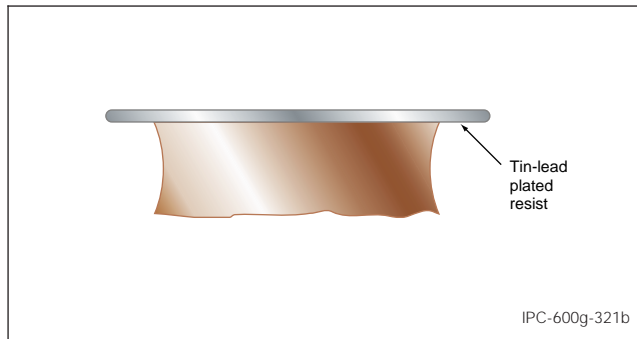

Pattern plating (dry film resist) prior to reflow

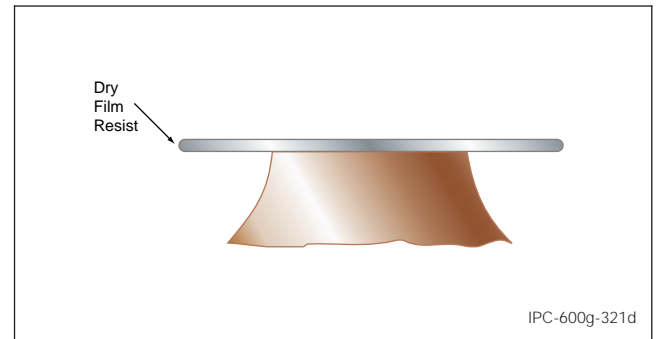

Panel plating (dry film resist) prior to resist stripping

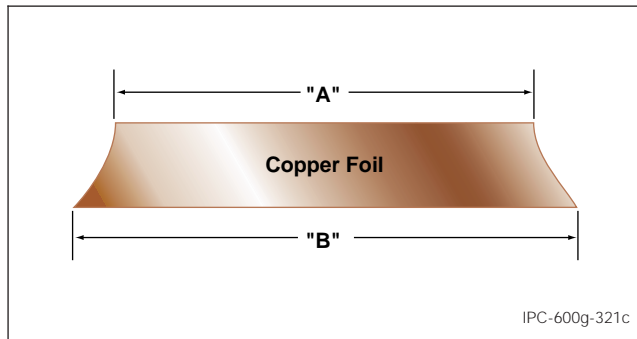

Internal layer after etch

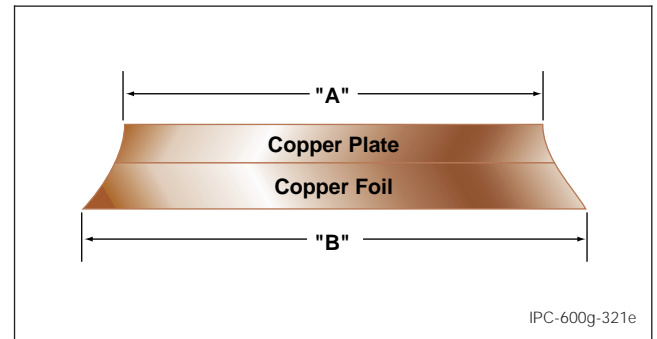

Internal plated layer as used for buried vias

Visual observations made on cross-sections only.

3.2 CONDUCTIVE PATTERNS – GENERAL

3.2.1 Etching Characteristics (cont.)

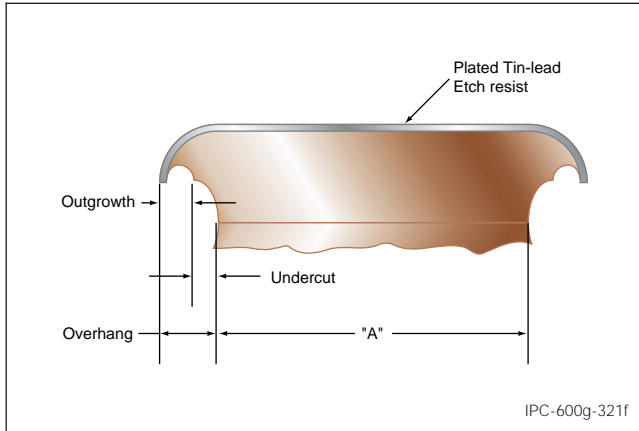

Pattern plating (dry film resist) with outgrowth

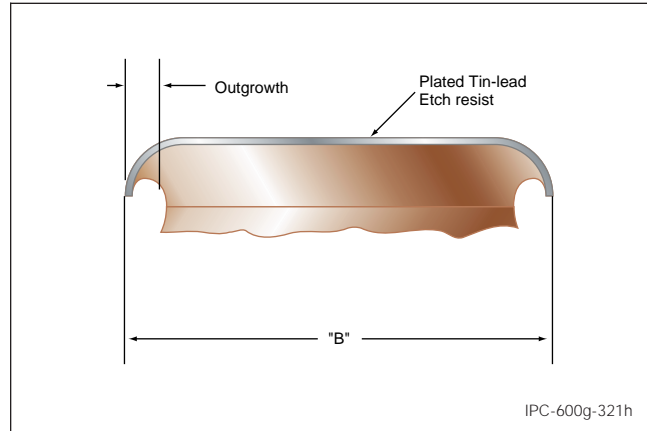

Pattern plating (liquid resist) with outgrowth

Note: The extent of outgrowth, if present, is related to the dry film resist thickness. Outgrowth occurs when the plating thickness exceeds the resist thickness.

Note: The different etch configurations may not meet intended design requirements.

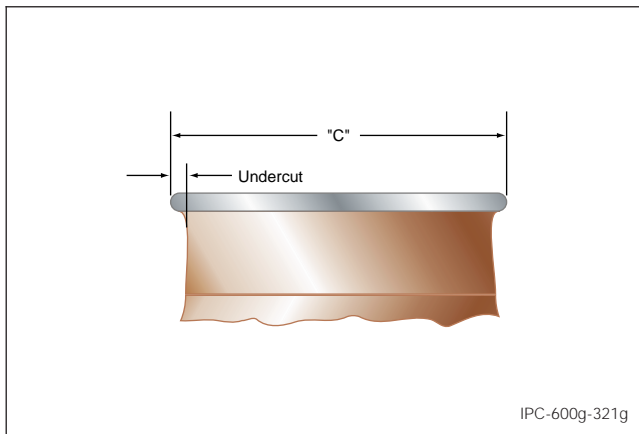

Thin clad & pattern plating (etch resist)

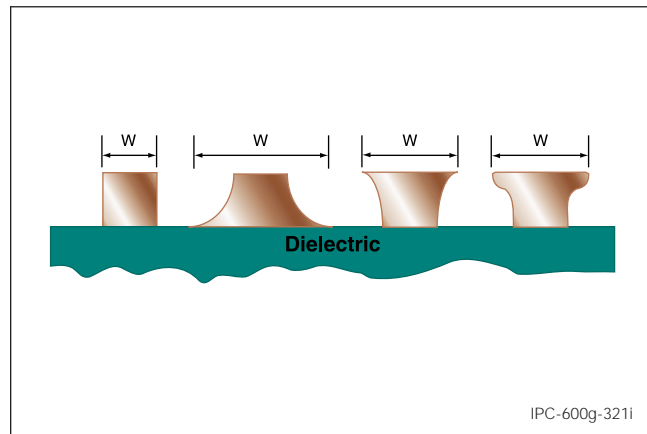

The effective width of a conductor may vary from the conductor width from surface obstructions (W).

Visual observations made on cross-sections only.

3.2 CONDUCTIVE PATTERNS – GENERAL

3.2.2 Print and Etch

The copper conductor may consist of combinations of copper foil, copper plating and electroless copper. Metal resist, solder coatings, and reflowed tin-lead plating that would normally be seen in a microsection are not shown in these illustrations.

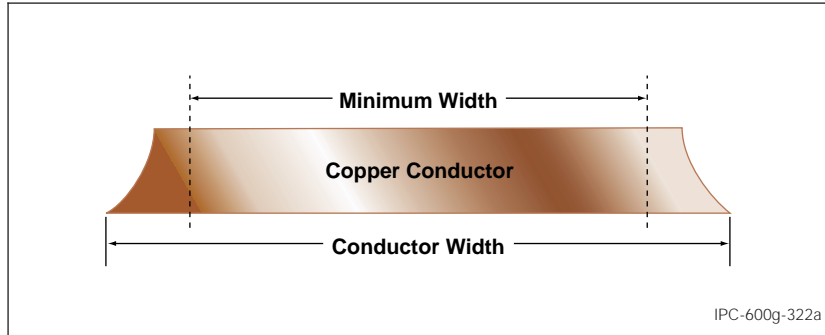

Target Condition – Class 1, 2, 3

- Conductor width exceeds minimum requirement.

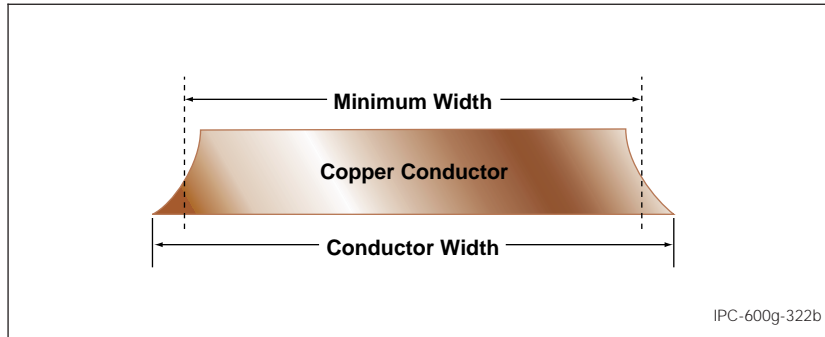

Acceptable – Class 1, 2, 3

- Conductor width meets minimum requirement.

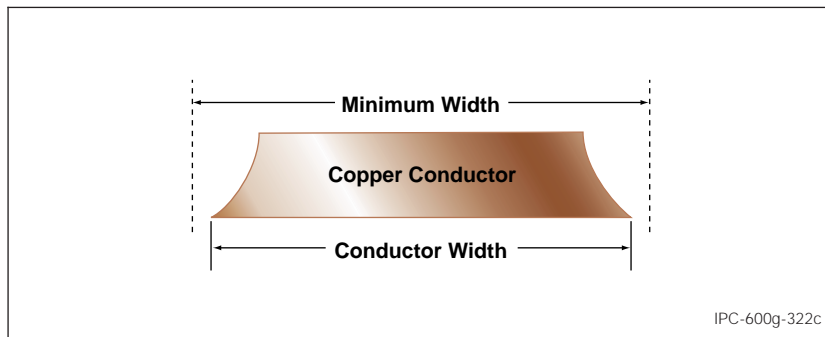

Nonconforming - Class 1, 2, 3

- Defects either do not meet or exceed above criteria.

Visual observations made on cross-sections only.

3.2 CONDUCTIVE PATTERNS – GENERAL

3.2.3 Surface Conductor Thickness (Foil Plus Plating)

Unless otherwise specified on the procurement documentation, the minimum total (copper foil plus copper plating) conductor thickness after processing **shall** be in accordance with Table 3-1.

Table 3-1 External Conductor Thickness after Plating

Weight	Absolute Cu Min. (IPC-4562 less 10% reduction) (µm) [µin]	Plus minimum plating for Class 1 and 2 (20 µm) [787 µin]	Plus minimum plating for Class 3 (25 µm) [984 µin]	Maximum Variable Processing Allowance Reduction* (µm) [µin]	Minimum Surface Conductor Thickness after Processing (µm) [µin]	
					Class 1 & 2	Class 3
1/8 oz.	4.60 [181]	24.60 [967]	29.60 [1,165]	1.50 [59]	23.1 [909]	28.1 [1,106]
1/4 oz.	7.70 [303]	27.70 [1,091]	32.70 [1,287]	1.50 [59]	26.2 [1,031]	31.2 [1,228]
3/8 oz.	10.80 [425]	30.80 [1,213]	35.80 [1,409]	1.50 [59]	29.3 [1,154]	34.3 [1,350]
1/2 oz.	15.40 [606]	35.40 [1,394]	40.40 [1,591]	2.00 [79]	33.4 [1,315]	38.4 [1,512]
1 oz.	30.90 [1,217]	50.90 [2,004]	55.90 [2,201]	3.00 [118]	47.9 [1,886]	52.9 [2,083]
2 oz.	61.70 [2,429]	81.70 [3,217]	86.70 [3,413]	3.00 [118]	78.7 [3,098]	83.7 [3,295]
3 oz.	92.60 [3,646]	112.60 [4,433]	117.60 [4,630]	4.00 [157]	108.6 [4,276]	113.6 [4,472]
4 oz.	123.50 [4,862]	143.50 [5,650]	148.50 [5,846]	4.00 [157]	139.5 [5,492]	144.5 [5,689]

Reference: Min. Cu Plating Thickness Class 1 = 20 µm [787 µin] Class 2 = 20 µm [787 µin] Class 3 = 25 µm [984 µin]

* Process allowance reduction does not allow for rework processes for weights below 1/2 oz. For 1/2 oz. and above, the process allowance reduction allows for one rework process.

3.2.4 Foil Thickness – Internal Layers

Minimum foil thickness (or conductor thickness) is the maximum continuous coplanar thickness that will conduct electrical current. Individual scratches are included, but the saw-toothed shaped “dendritic” surface for metal-clad adhesion promotion is excluded from the minimum foil thickness determination.

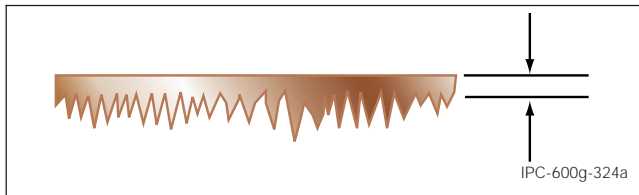

The minimum internal layer foil thickness after processing **shall** be in accordance with Table 3-2.

Table 3-2 Internal Layer Foil Thickness after Processing

Weight	Absolute Cu Min. (IPC-4562 less 10% reduction) (µm) [µin]	Maximum Variable Processing Allowance Reduction* (µm) [µin]	Minimum Final Finish after Processing (µm) [µin]
1/8 oz. [5.10]	4.60 [181]	1.50 [59]	3.1 [122]
1/4 oz. [8.50]	7.70 [303]	1.50 [59]	6.2 [244]
3/8 oz. [12.00]	10.80 [425]	1.50 [59]	9.3 [366]
1/2 oz. [17.10]	15.40 [606]	4.00 [157]	11.4 [449]
1 oz. [34.30]	30.90 [1,217]	6.00 [236]	24.9 [980]
2 oz. [68.60]	61.70 [2,429]	6.00 [236]	55.7 [2,193]
3 oz. [102.90]	92.60 [3,646]	6.00 [236]	86.6 [3,409]
4 oz. [137.20]	123.50 [4,862]	6.00 [236]	117.5 [4,626]
Above 4 oz. [137.20]		6.00 [236]	6 µm [236 µin] below minimum thickness of calculated 10% reduction of foil thickness in IPC-4562

* Process allowance reduction does not allow for rework processes for weights below 1/2 oz. For 1/2 oz. and above, the process allowance reduction allows for one rework process.

Note: Additional platings that may be required for internal layer conductors **shall** be separately designated as a plating thickness requirement.

Visual observations made on cross-sections only.

3.3 PLATED-THROUGH HOLES – GENERAL

Introduction

This section identifies the acceptability characteristics in plated-through holes used in double-sided and multilayer rigid printed boards. Included in this section are photographic and illustrative depictions of plated-through hole characteristics for both drilled and punched holes, with separate examples where appropriate.

The test specimen **shall** be a representative coupon such as described in IPC-2221, a portion of the printed wiring board being tested, or a whole board if within size limits.

Sample holes should be selected at random. Vertical microsections, both parallel and perpendicular to a board edge are recommended. Horizontal microsectioning techniques may be used as the referee. Precise encapsulation and metallurgical techniques must be used to assure highly polished sections with correct part alignment and polishing to the mean of the hole diameter. The polished surface should be etched after initial smear evaluation and just prior to plating thickness measurements.

The evaluation of all properties and requirements **shall** be performed on the thermally stressed test coupon and all requirements must be met; however, per supplier election, certain properties and conditions which are not affected by thermal stressing may be evaluated in a test coupon(s) that has not been thermally stressed.

- a) When a supplier elects to evaluate the unstressed test coupon for the properties in (b), he may do so at any operation following the copper plating operation. If the board undergoes additional thermal excursions above the T_g (glass transition temperature) after copper plating, the unstressed test coupon being evaluated **shall** also be subjected to these thermal excursions.
- b) The properties which are not affected by thermal stress include but are not limited to: copper voids, plating folds/inclusions, burrs and nodules, glass fiber protrusion, wicking, final coating plating voids, etchback, negative etchback, plating/coating thickness, internal and surface copper layer or foil thickness.

Methods of Inspection:

- **Hole Size (method optional - IPC-TM-650, Method 2.2.7)**

- A. Optical
- B. Document drill blank plug or plug gages
- C. Tapered hole gage

Note: hole gages must be cleaned and storage oil must be removed prior to use.

- **Visual hole wall quality**

- A. Voids, Nodules, etc., - locate with unaided eye, use up to 10X magnification for verification.
- B. Discolorations, Stains, etc., - use unaided eye and/or solderability tests.

3.3 PLATED-THROUGH HOLES – GENERAL

Introduction (cont.)

Microsection:

• Plating thickness measurements

- A. Encapsulated Microsection Examination (IPC-TM-650, Method 2.1.1 or Method 2.1.1.2): The average copper thickness should be determined from three measurements, approximately equally spaced, on each side of the plated-through hole. Do not measure in areas having isolated imperfections such as voids, cracks or nodules. Variations in cracks can be defined per the illustration below. Small localized areas with plating thickness less than minimum requirement are evaluated as voids.
- B. Nondestructive Method: Micro-ohm Measurements (IPC-TM-650, Method 2.2.13.1): This technique may be used to measure the average copper thickness in plated-through holes when properly standardized. The method has application to measurement of the minimum copper thickness. Due to the dependence on uniform hole geometry this method may not be appropriate for measurement of punched plated-through holes. The nondestructive feature and the speed and ease of measurement make this method useful in providing variable data for statistical process control.
- C. Plating Thickness: Minimum requirements are established in IPC-6010 series.

• Solderability

A lot sample or representative specimen should be subjected to a solderability test utilizing Methods B, C, or D of ANSI/J-STD-003. The coating durability requirement should be pre-established. The plated-through holes should exhibit good wetting and capillary action.

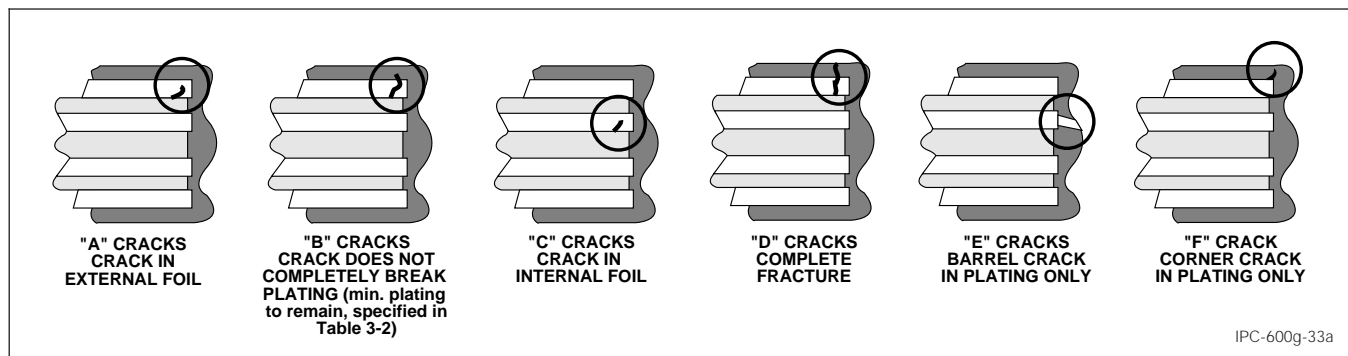

Visual observations made on cross-sections only.

3.3 PLATED-THROUGH HOLES – GENERAL

3.3.1 Annular Ring – Internal Layers

For multilayer boards, in addition to physical measurements of board surfaces, if internal annular ring breakout is detected in the vertical cross section, but the degree of breakout cannot be determined, internal registration may be assessed by nondestructive techniques other than microsection, such as, special patterns, probes, and/or software, which are configured to provide information on the interpolated annular ring remaining and pattern skew. Techniques include, but are not limited to the following:

- The optional F coupon detailed in IPC-2221.
- Custom designed electrically testable coupons.
- Radiographic (x-ray) techniques.
- Horizontal microsection.
- CAD/CAM data analysis as correlated to pattern skew by layer.

Note: Microsectioning or statistical sampling **shall** be used to verify correlation of the approved technique, and a calibration standard established for the specific technique employed.

If misregistration to the point of breakout is detected in vertical microsections, the concerns are that:

1. The conductor width minimum may be compromised at the land junction and,
2. There is insufficient electrical spacing.

The extent and direction of breakout **shall** be determined. Appropriate test coupons such as those described in IPC-2221 or actual production boards **shall** be tested at the affected area(s) and analyzed on the suspect layer(s) to determine compliance. This may be accomplished by the techniques listed above.

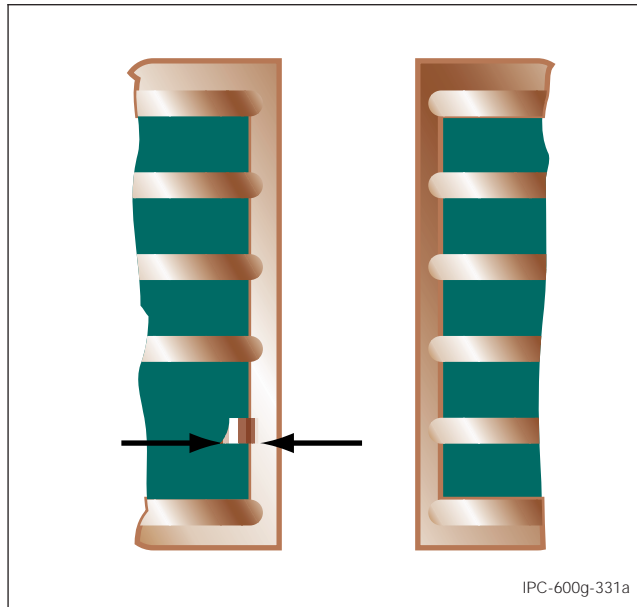

Visual observations made on cross-sections only.

3.3 PLATED-THROUGH HOLES – GENERAL

3.3.1 Annular Ring – Internal Layers (cont.)

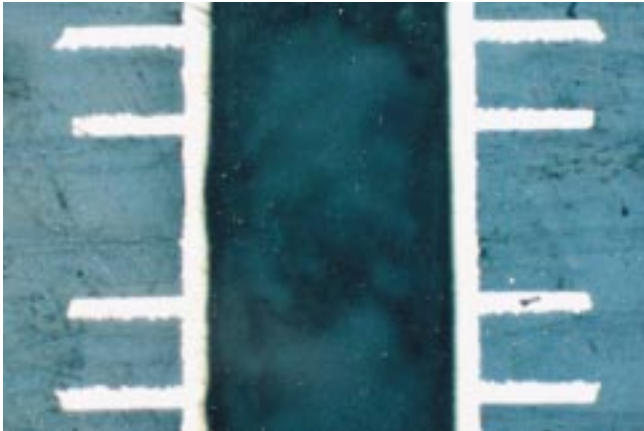

Target Condition – Class 1, 2, 3

- All holes accurately registered in center of a land.

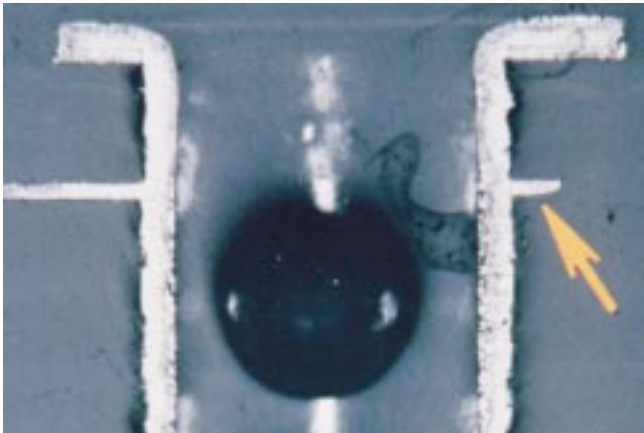

Acceptable – Class 3

- Annular ring measures 0.025 mm [0.000984 in] or more.

Acceptable – Class 1, 2

- Hole breakout is allowed provided the land/conductor junction is not reduced below the allowable width reduction in 2.10.1.1 and minimum lateral spacing is maintained.

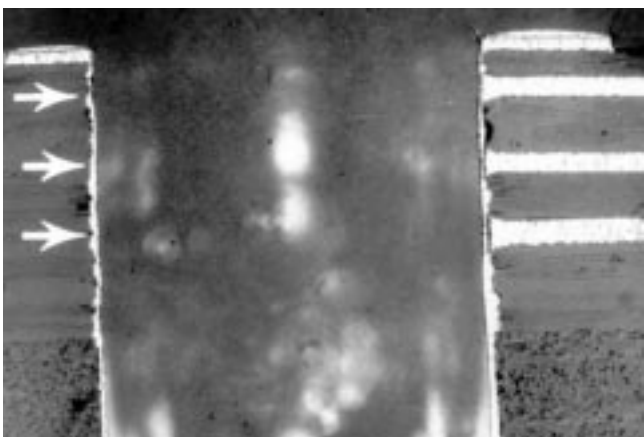

Nonconforming - Class 1, 2, 3

- Defects either do not meet or exceed above criteria.

Note: If misregistration to the point of breakout is detected in vertical microsections, the concerns are that:

1. The conductor width minimum may be compromised at the land junction and,
2. There is insufficient electrical spacing.

The extent and direction of breakout **shall** be determined. Appropriate test coupons or actual production boards **shall** be tested at the affected area(s) and analyzed on the suspect layer(s) to determine compliance. This may be accomplished by the techniques listed above.

Visual observations made on cross-sections only.

3.3 PLATED-THROUGH HOLES - GENERAL

3.3.2 Lifted Lands - (Cross-Sections)

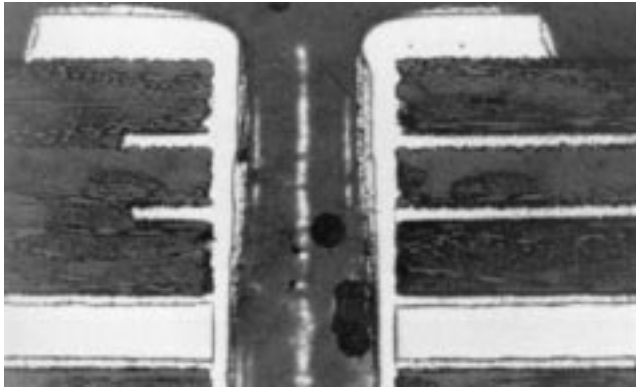

Target Condition - Class 1, 2, 3

- No lifting of lands.



Acceptable - Class 1, 2, 3

After thermal stress testing or rework simulation:

- Lifted lands are allowed.

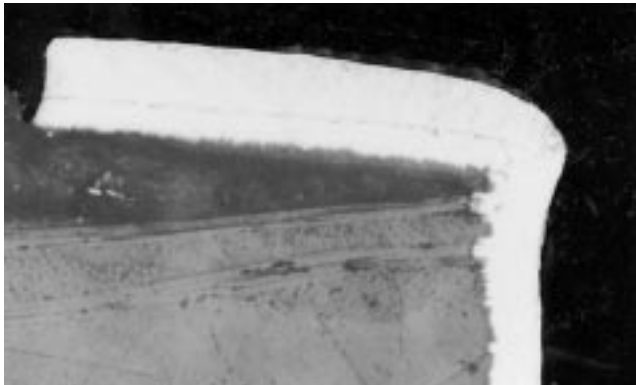

Visual observations made on cross-sections only.

3.3 PLATED-THROUGH HOLES - GENERAL

3.3.3 Foil Crack - (Internal Foil) "C" Crack



Target Condition - Class 1, 2, 3

- No cracks in foil.

Acceptable - Class 2, 3

- No evidence of cracks in foil.

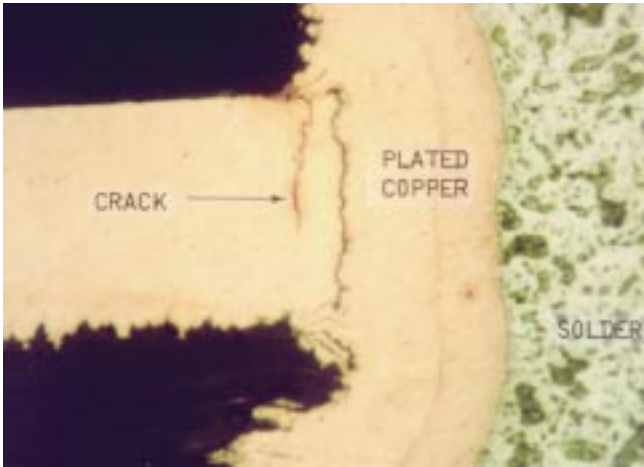

Acceptable - Class 1

- Allowed on one side of hole only and **shall not** extend through foil thickness.

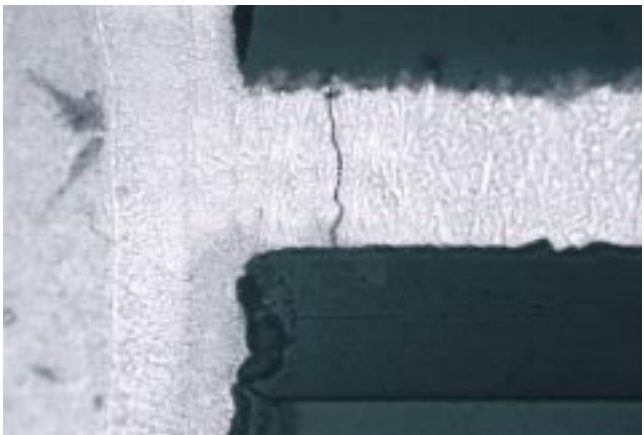

Nonconforming - Class 1, 2, 3

- Defects either do not meet or exceed above criteria.

Visual observations made on cross-sections only.

3.3 PLATED-THROUGH HOLES – GENERAL

3.3.4 Foil Crack (External Foil)

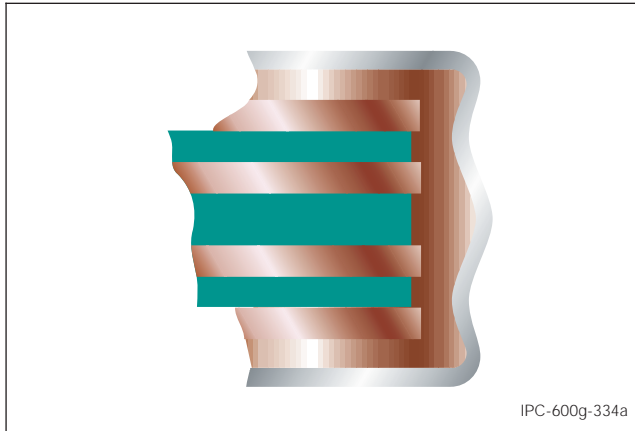

Target Condition – Class 1, 2, 3

- No cracks in foil.

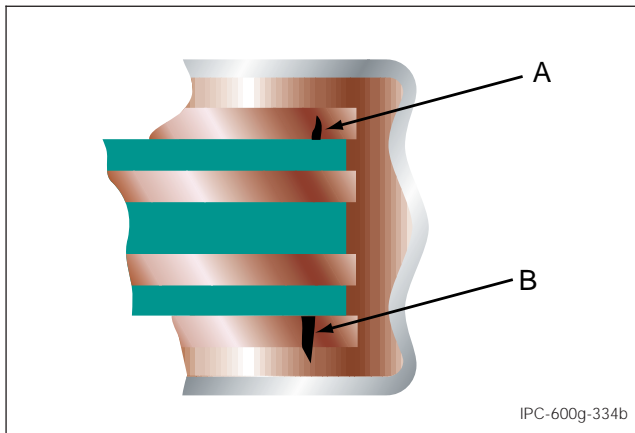

Acceptable – Class 1, 2, 3

- Crack A

Acceptable – Class 1

- Crack B

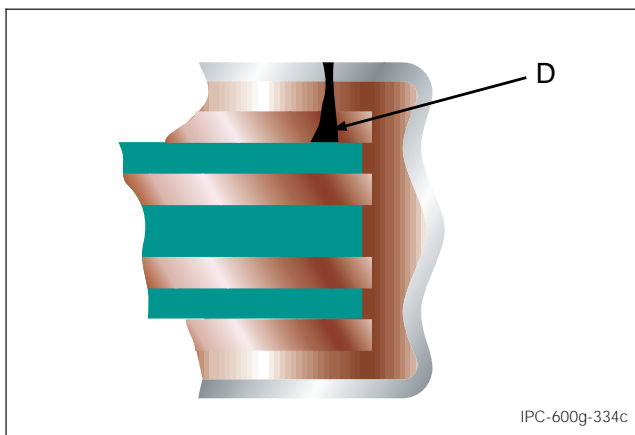

Nonconforming - Class 1, 2, 3

- Defects either do not meet or exceed above criteria.

Note: "A" Crack is a crack in external foil.

"B" Crack is a crack that does not completely break plating (minimum plating remains).

"D" Crack is a complete crack through external foil and plating.

Visual observations made on cross-sections only.

3.3 PLATED-THROUGH HOLES - GENERAL

3.3.5 Plating Crack - (Barrel) "E" Crack

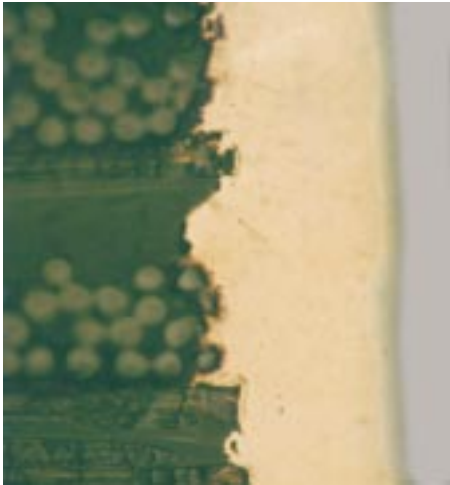

Target Condition - Class 1, 2, 3

- Barrel plating is free of cracks.

Acceptable - Class 1, 2, 3

- No cracks in plating.

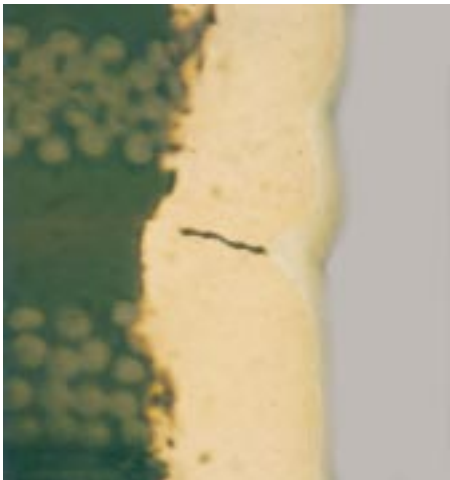

Nonconforming - Class 1, 2, 3

- Defects either do not meet or exceed above criteria.

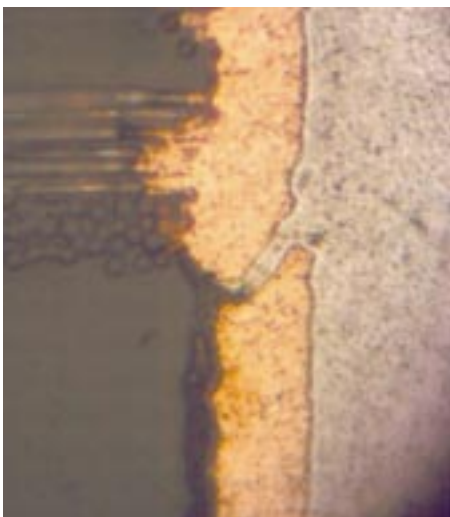

Visual observations made on cross-sections only.

3.3 PLATED-THROUGH HOLES - GENERAL

3.3.6 Plating Crack – (Corner) "F" Crack

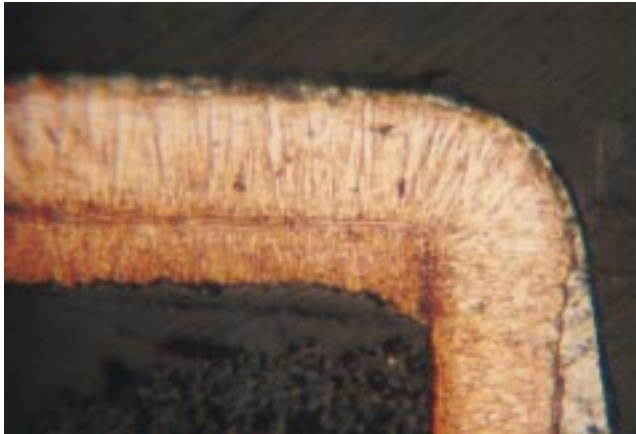

Target Condition – Class 1, 2, 3

- No cracks in plating.

Acceptable – Class 1, 2, 3

- No cracks in plating.

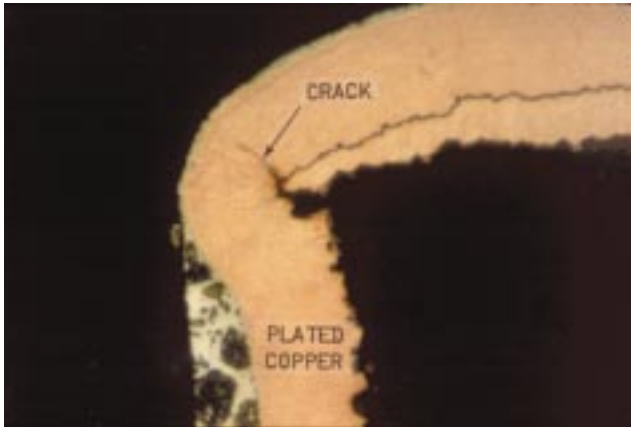

Nonconforming - Class 1, 2, 3

- Defects either do not meet or exceed above criteria.

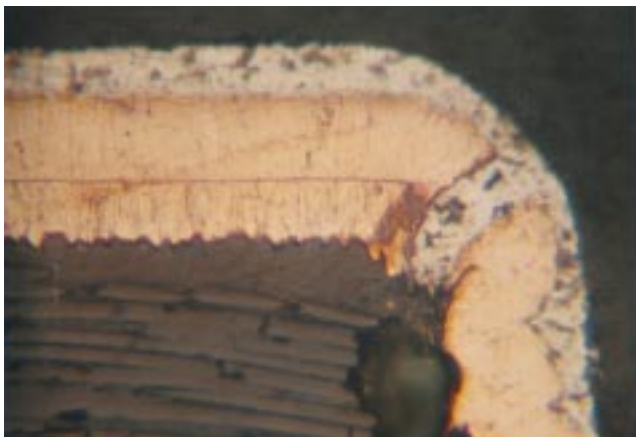

Visual observations made on cross-sections only.

3.3 PLATED-THROUGH HOLES – GENERAL

3.3.7 Plating Nodules

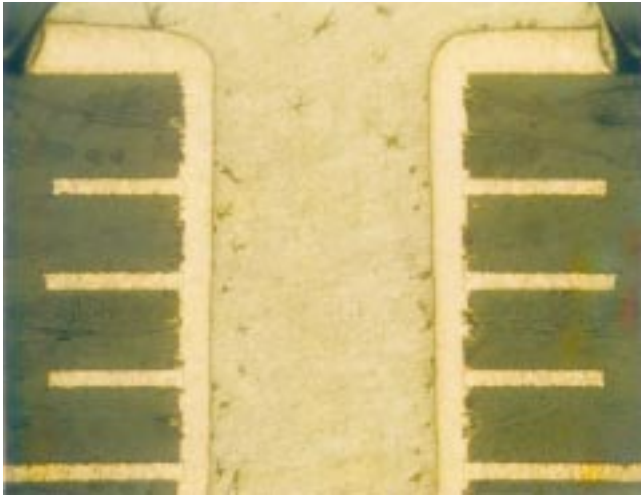

Target Condition – Class 1, 2, 3

- Plating is smooth and uniform throughout the hole. No evidence of roughness or nodules.



Acceptable – Class 1, 2, 3

- Roughness or nodules do not reduce plating thickness below absolute minimum requirements or hole diameter below minimum requirements.



Nonconforming - Class 1, 2, 3

- Defects either do not meet or exceed above criteria.

Visual observations made on cross-sections only.

3.3 PLATED-THROUGH HOLES – GENERAL

3.3.8 Copper Plating Thickness – Hole Wall

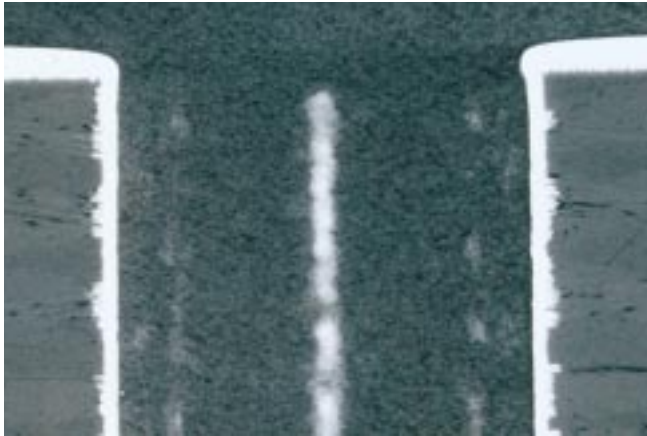

Target Condition – Class 1, 2, 3

- Plating is smooth and uniform throughout the hole. Plating thickness meets requirements.



Acceptable – Class 1, 2, 3

- Plating thickness varies but meets minimum average requirements and minimum thin area requirements in the IPC-6010 Series.
- Small localized areas with plating thickness less than minimum requirement are evaluated as voids.



Nonconforming - Class 1, 2, 3

- Defects either do not meet or exceed above criteria.

Visual observations made on cross-sections only.

3.3 PLATED-THROUGH HOLES – GENERAL

3.3.9 Plating Voids

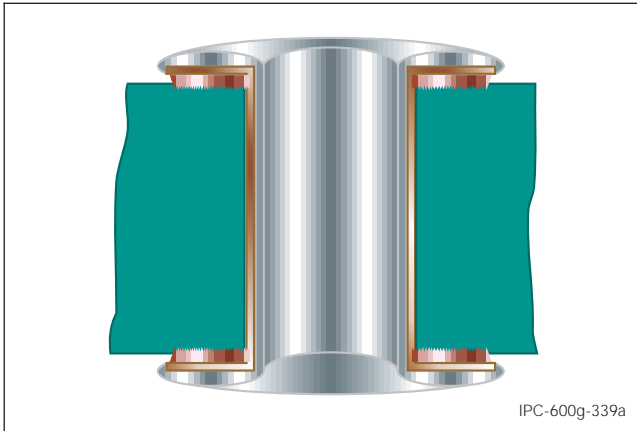

Target Condition – Class 1, 2, 3

- Hole is free of voids.

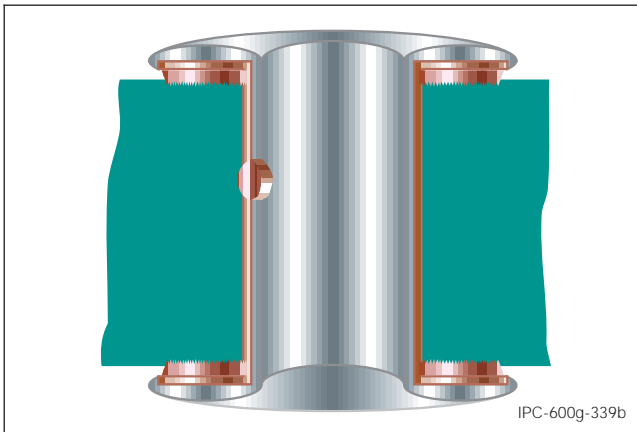

Acceptable - Class 2, 3

- No more than one plating void per test coupon or production board, regardless of length or size.
- No plating void in excess of 5 percent of the total printed wiring board thickness.
- No plating voids evident at the interface of an internal conductive layer and plated hole wall.
- Plating voids less than or equal to 90° of the circumference.

Acceptable - Class 1

- No more than three plating voids per test coupon or production board, regardless of length or size.
- No plating void in excess of 5 percent of the total printed wiring board thickness.
- No plating voids evident at the interface of an internal conductive layer and plated hole wall.
- Plating voids less than or equal to 90° of the circumference.

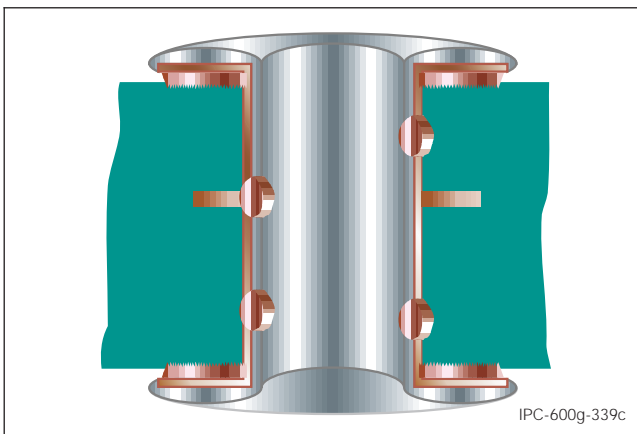

Nonconforming - Class 1, 2, 3

- Defects either do not meet or exceed above criteria.

Visual observations made on cross-sections only.

3.3 PLATED-THROUGH HOLES – GENERAL

3.3.10 Solder Coating Thickness (Only When Specified)

Solder coating thickness, when specified, **shall** be evaluated prior to thermal stress

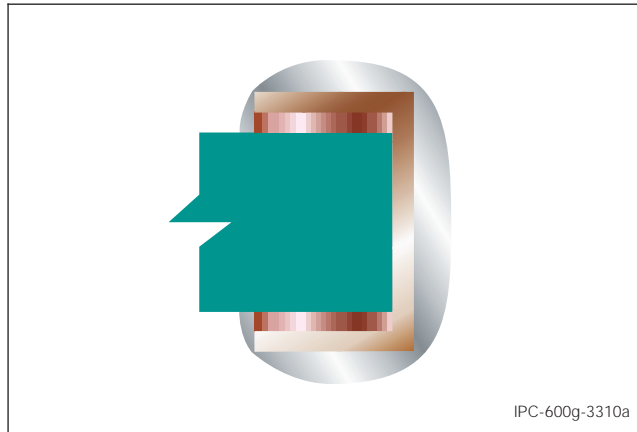

Target Condition – Class 1, 2, 3

- Solder coating thickness is uniform and covers etched land edge. Exposed copper is not evident.

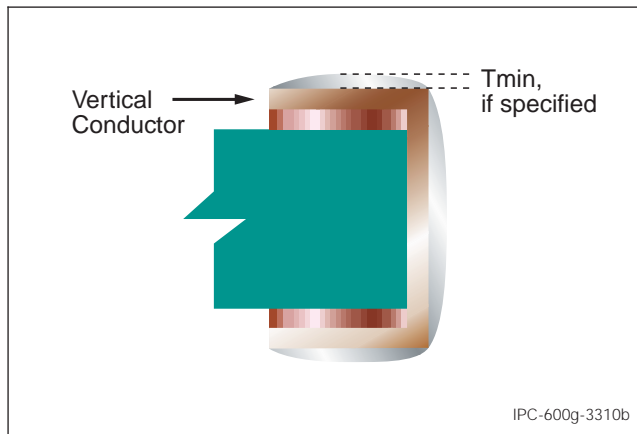

Acceptable – Class 1, 2, 3

- Solder coating thickness is uniform. Vertical (conductor and land) areas may not be covered. No exposed copper is evident.

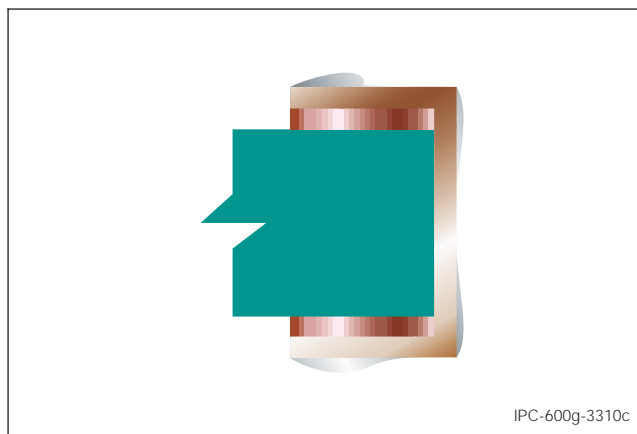

Nonconforming - Class 1, 2, 3

- Defects either do not meet or exceed above criteria.

Note: For solderability requirements, see 5.1.

Visual observations made on cross-sections only.

3.3 PLATED-THROUGH HOLES – GENERAL

3.3.11 Solder Resist Thickness

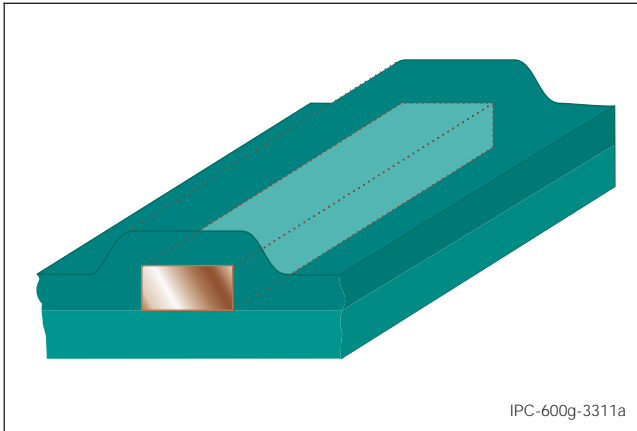

Target Condition - Class 1, 2, 3

- Thickness as specified on procurement documentation.

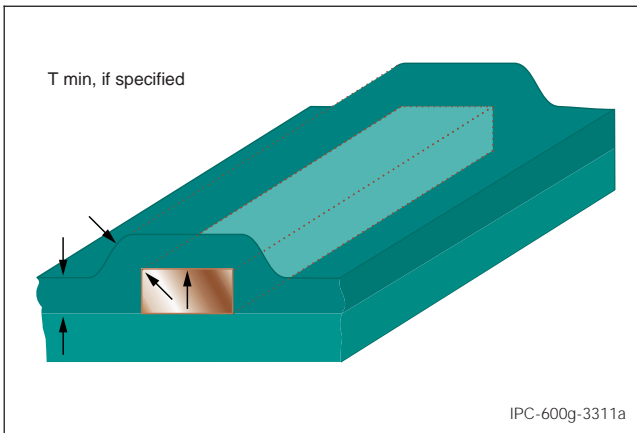

Acceptable - Class 1, 2, 3

- Specified: The solder resist thickness meets the thickness requirements on the procurement documentation (cannot be visually assessed).

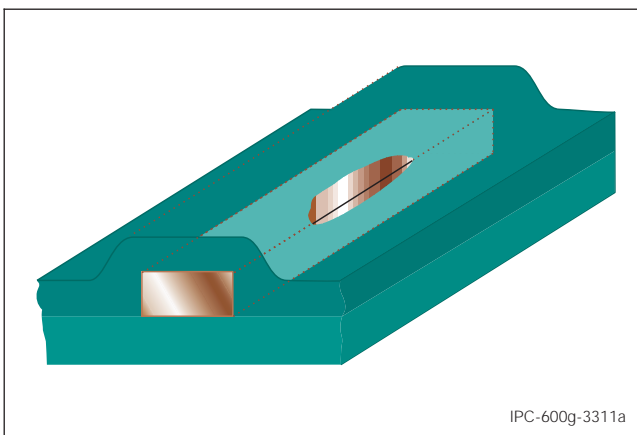

Nonconforming - Class 1, 2, 3

- Defects do not meet above criteria.

3.3 PLATED-THROUGH HOLES – GENERAL

3.3.12 Wicking



Target Condition – Class 1, 2, 3

- No wicking present.

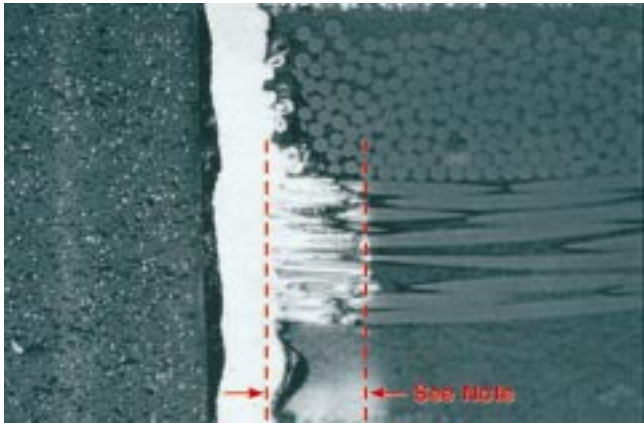

Acceptable – Class 3

- Wicking does not exceed 80 μm [3,150 μin].

Acceptable – Class 2

- Wicking does not exceed 100 μm [3,937 μin].

Acceptable – Class 1

- Wicking does not exceed 125 μm [4,291 μin].

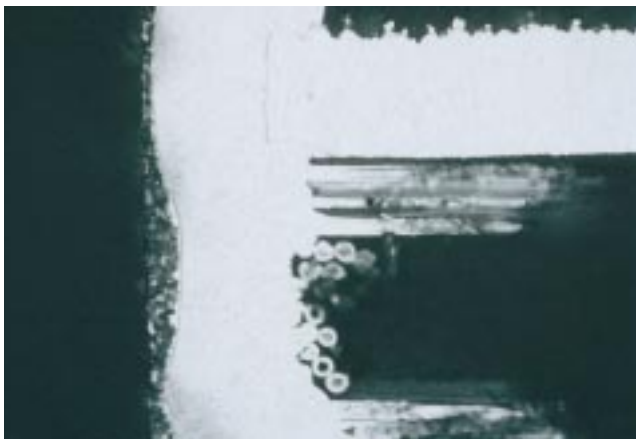

Nonconforming – Class 1, 2, 3

- Defects exceed above criteria.

Note: Wicking is measure from the laminate edge excluding the plating.

Visual observations made on cross-sections only.

3.3 PLATED-THROUGH HOLES – GENERAL

3.3.12.1 Wicking, Clearance Holes

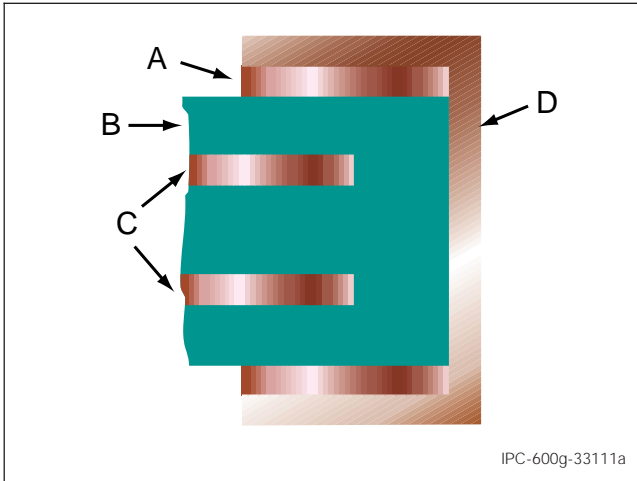

- A) Surface Pad
B) Dielectric
C) Adjacent Noncommon Conductors
D) Surface Plating

Target Condition – Class 1, 2, 3

- No wicking of conductive material into base material or along the reinforcement material.

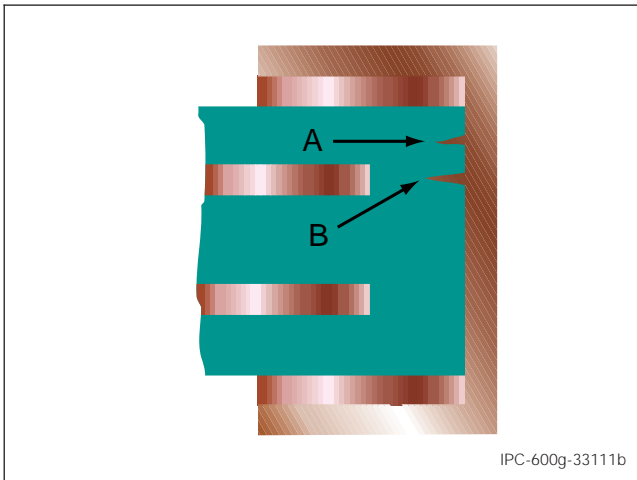

Acceptable – Class 1, 2, 3

- Wicking (B) does not reduce spacing less than specified minimum on the procurement documentation.

Acceptable – Class 3

- Wicking (A) does not exceed 80 μm [3,150 μin].

Acceptable – Class 2

- Wicking (A) does not exceed 100 μm [3,937 μin].

Acceptable – Class 1

- Wicking (A) does not exceed 125 μm [4,291 μin].

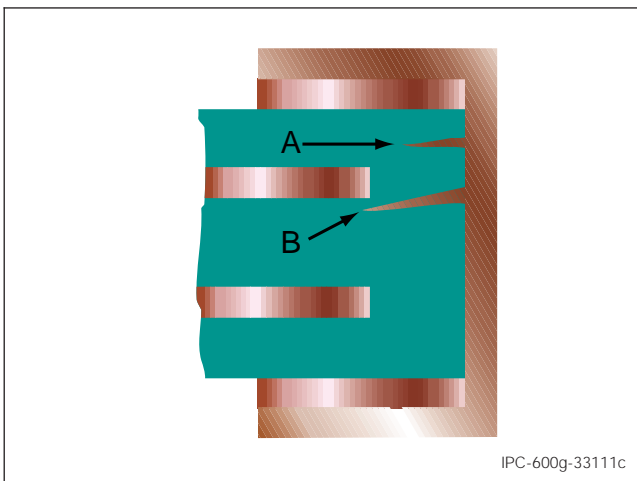

Nonconforming - Class 1, 2, 3

- Defects either do not meet or exceed above criteria.

Visual observations made on cross-sections only.

3.3 PLATED-THROUGH HOLES – GENERAL

3.3.13 Innerlayer Separation – Vertical (Axial) Microsection

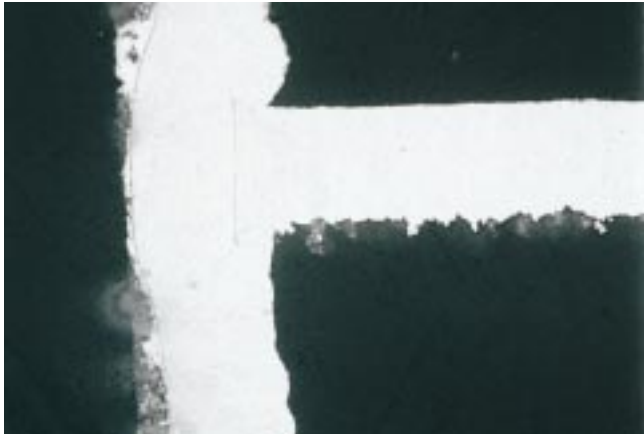

Target Condition – Class 1, 2, 3

- Direct bond of plated copper to copper foil. No evidence of innerlayer separation (separation between internal lands and plating of the hole wall) or innerlayer inclusions.

Acceptable – Class 2, 3

- No separation evident.



Acceptable – Class 1

- Partial innerlayer separation or innerlayer inclusions on only one side of hole wall at each land location on no more than 20% of each available land.



Nonconforming - Class 1, 2, 3

- Defects either do not meet or exceed above criteria.

Visual observations made on cross-sections only.

3.3.14 Innerlayer Separation – Horizontal (Transverse) Microsection

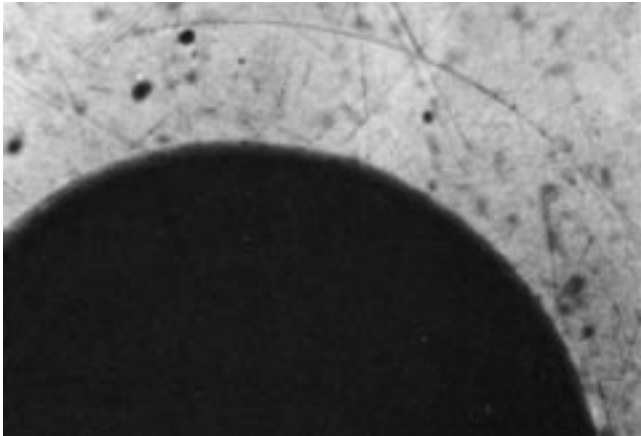

Target Condition – Class 1, 2, 3

- No separation between the internal layer and plating in the hole. Direct bond of plated copper to layer foil copper. Line of demarcation caused by preferential etching of electroless copper deposit.

Acceptable – Class 2, 3

- No separation evident.

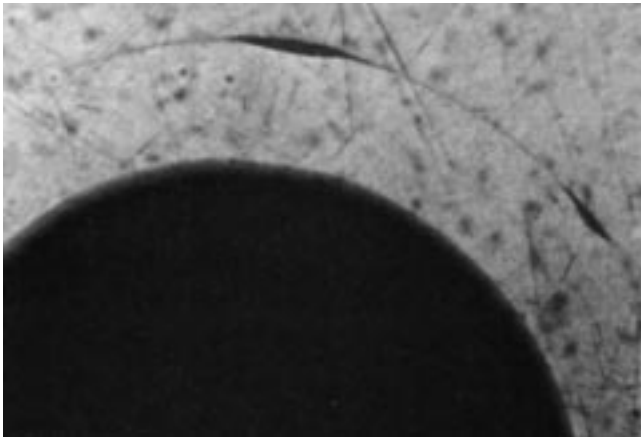

Acceptable – Class 1

- Slight line of demarcation and localized minor innerlayer separation that does not exceed specified requirements.

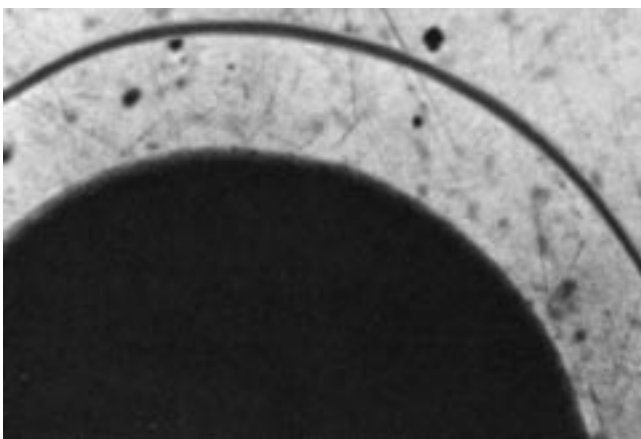

Nonconforming - Class 1, 2, 3

- Defects either do not meet or exceed above criteria.

Visual observations made on cross-sections only.

3.3 PLATED-THROUGH HOLES – GENERAL

3.3.15 Material Fill of Blind and Buried Vias

Blind via holes should be filled or plugged with a polymer or solder resist to prevent solder from entering them as solder in the small holes tends to decrease reliability. Incomplete via fill may result in board delamination due to the rapid expansion of entrapped air pockets or flux contaminants during solder reflow processes. Requirements for buried via fill are listed below.

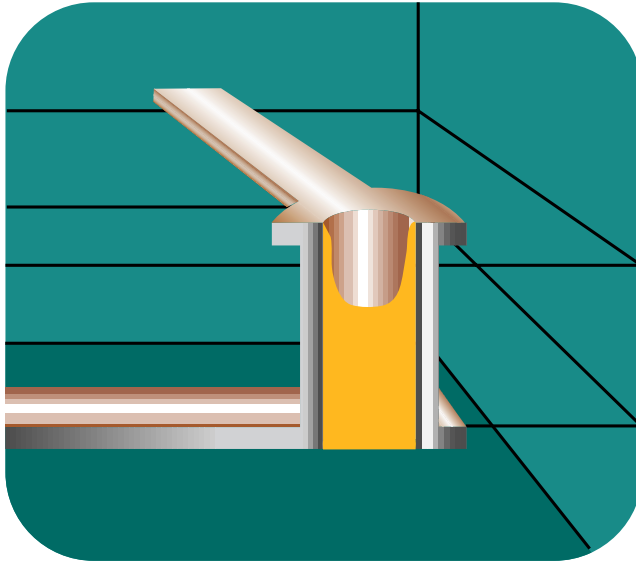

Acceptable - Class 2, 3

- At least 60% buried via fill with laminating resin or similar via fill material.

Acceptable - Class 1

- Buried via completely void of fill material.

Nonconforming - Class 1, 2, 3

- Defects either do not meet or exceed above criteria.

Visual observations made on cross-sections only.

3.4 PLATED-THROUGH HOLES – DRILLED

Introduction

This section identifies the acceptability characteristics for drilled plated-through holes. Although only two characteristics are identified (burrs and nailheading), good drilling is essential for a good plated-through hole. The drilled hole wall should be smooth and free of burrs, delamination, burning, crushed insulation, and protruding fibers. The hole should be perpendicular, round and not tapered. A poorly drilled hole may cause other problems that have been described and characterized in other sections of this document. These problems are:

- Rough plating
- Nodules
- Plating voids
- Thin plating
- Plating cracks (hole wall, corner)
- Wicking (excessive)
- Hole size reduction
- Pink ring
- Blow holes in soldering
- Skip plating

The physical appearance of a particular hole will be affected by one or more of the following variables:

- Drill point angle
- Drill rotation speed
- Drill feed rate
- Drill sharpness

Nailheading is a condition which may develop during the drilling operation. Worn drills, improper speeds and feeds, and/or soft back up and entry materials usually cause nailheading. The condition is acceptable for all classes.

Visual observations made on cross-sections only.

3.4 PLATED-THROUGH HOLES – DRILLED

3.4.1 Burrs



Target Condition – Class 1, 2, 3

- No evidence of burrs.

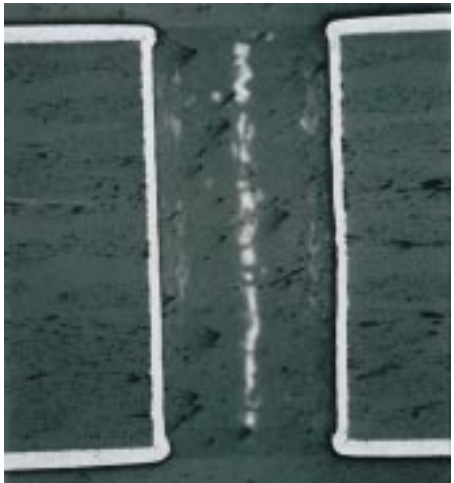

Acceptable - Class 1, 2, 3

- Burrs are acceptable for all classes provided they do not reduce hole diameter or plating thickness below required minimums.

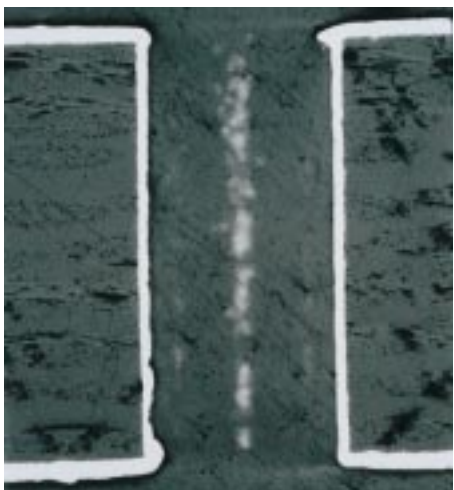

Nonconforming - Class 1, 2, 3

- Defects either do not meet or exceed above criteria.

Visual observations made on cross-sections only.

3.4 PLATED-THROUGH HOLES - DRILLED

3.4.2 Nailheading

No evidence exists that nail heading affects functionality. The presence of nail heading may be considered an indicator of process or design variation but is not a cause for rejection. Consider evaluation for glass bundle damage.



Visual observations made on cross-sections only.

3.5 PLATED-THROUGH HOLES – PUNCHED

Introduction

The figures below depict a punched hole and a punched and plated hole in a reinforced laminate. The figures show the characteristics which may be exhibited in a punched hole. Punched holes may appear different than drilled holes. Drilled holes have straight wall geometry while the geometry of punched holes will vary from straight to those seen in the figures. The difference in the hole characteristics are attributed to:

- Laminate type and thickness
- Thickness and type of cladding
- Design of punch and die
- Tool maintenance
- Processing techniques

The laminate type is very important in determining its punchability. Laminates in which all the base material is woven fabric are difficult to punch. The composite materials utilizing a woven fabric top and bottom sheet and a random fiber internal mat are easily punched and the straight wall geometry of the drilled hole can be approached. Punch and die clearance and sharpness are also important when a straight wall is desired and a small flare is required. The amount of flare, foil burr, foil intrusion, laminate bulge, and laminate rollover seen in the figures do not necessarily degrade the plated-through hole quality and are acceptable for all classes provided other requirements are in compliance with the performance specifications and the engineering description.

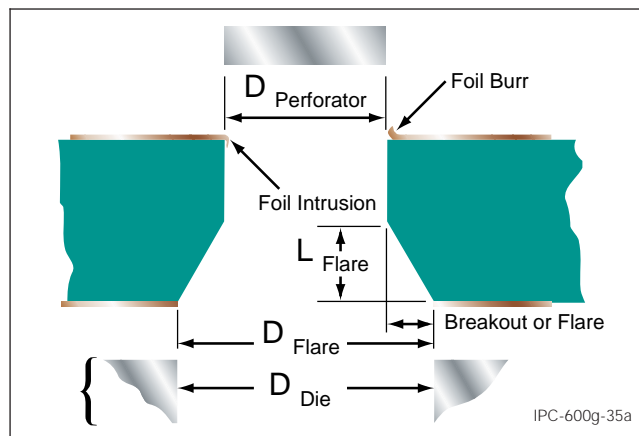

Punched

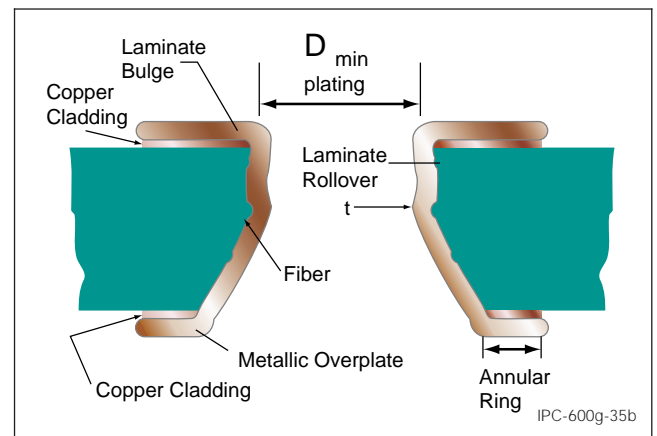

Punched and Plated

Although burrs and fibers can also be associated with the straight wall geometry of a drilled hole, the concepts of flare and intrusion relate specifically to punched hole formation techniques. An intrusion of copper foil within the punched hole can result from excessive punch-to-die clearance or a dull punch. Tapered flare or breakout is a normal condition on the exit side of a punched hole and may be caused by the stress generated within the laminate during hole formation. The degree of flare can be controlled through variations in punch-to-die clearance and other operating parameters.

Visual observations made on cross-sections only.

3.5 PLATED-THROUGH HOLES – PUNCHED

3.5.1 Roughness and Nodules

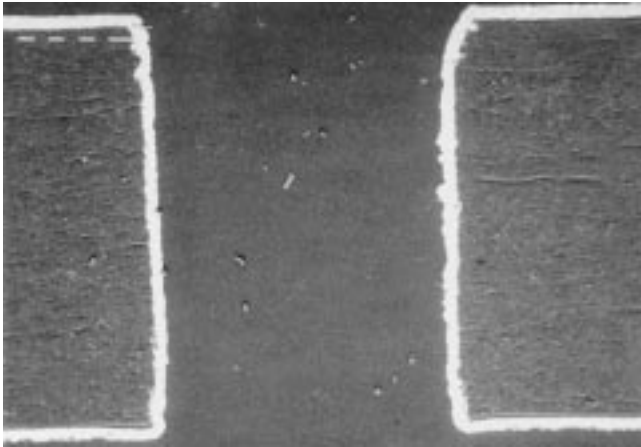

Target Condition – Class 1, 2, 3

- Plating is smooth and uniform throughout the hole. No evidence of roughness or nodules.

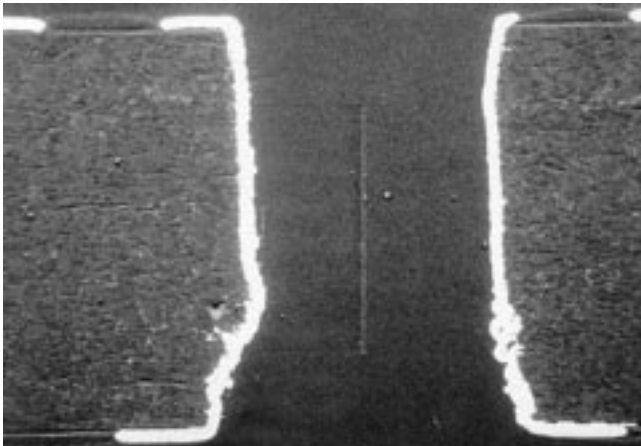

Acceptable – Class 1, 2, 3

- Roughness or nodules do not reduce plating thickness or hole diameter below minimum requirements.

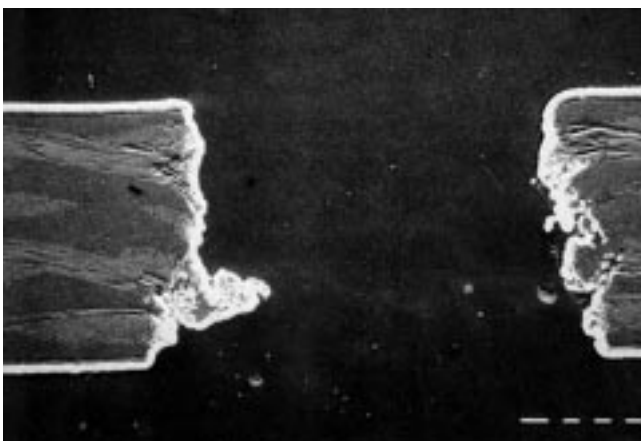

Nonconforming - Class 1, 2, 3

- Defects either do not meet or exceed above criteria.

Visual observations made on cross-sections only.

3.5 PLATED-THROUGH HOLES – PUNCHED

3.5.2 Flare

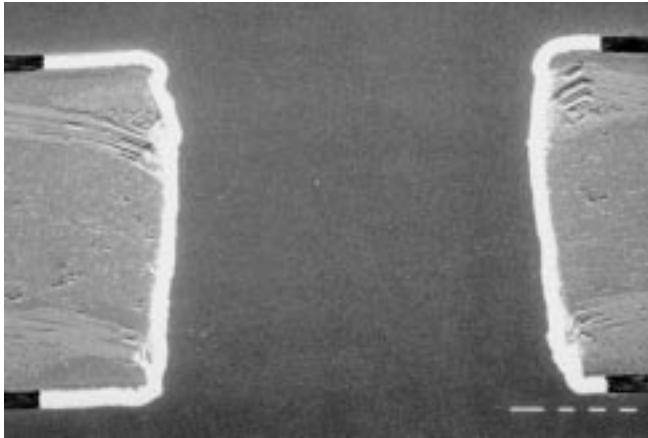

Target Condition – Class 1, 2, 3

- Hole exhibits only slight flare and does not violate minimum annular ring requirements.

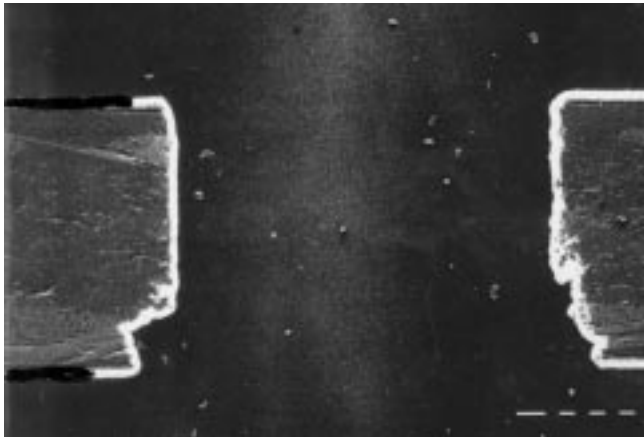

Acceptable – Class 1, 2, 3

- Hole exhibits flare but it does not violate minimum annular ring requirements.

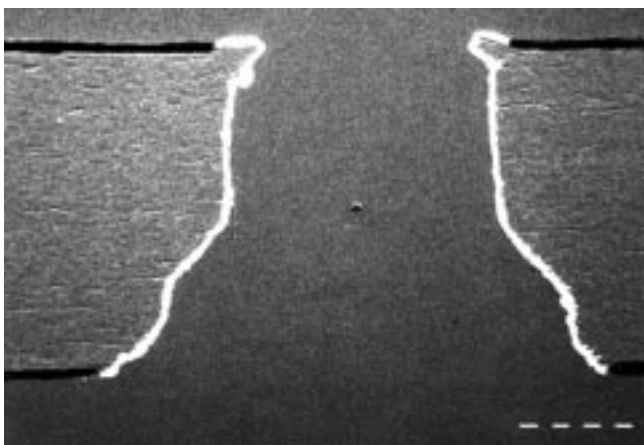

Nonconforming - Class 1, 2, 3

- Defects either do not meet or exceed above criteria.

Visual observations made on cross-sections only.

4.0 MISCELLANEOUS

Introduction

This section provides acceptability criteria for several special printed board types. The distinctive features of these special board types require supplementing the general acceptability criteria. For each special board type, this section outlines where and how the general acceptability criteria are supplemented. The special board types are:

- Flexible
- Rigid-Flex
- Metal Core
- Flush

4.1 FLEXIBLE AND RIGID-FLEX PRINTED WIRING

Introduction

This section covers the acceptability requirements specific to flexible and rigid-flex printed wiring. Parameters not covered in this section are to be evaluated using the other sections of this document.

The numeric type designator for flexible and rigid-flex printed wiring differs from that of rigid printed boards. The various types for flexible and rigid-flex printed wiring are defined as follows:

- Type 1. Single-sided flexible wiring containing one conductive layer with or without stiffeners.
- Type 2. Double-sided flexible printed wiring containing two conductive layers with plated-through holes with or without stiffeners.
- Type 3. Multilayer flexible printed wiring containing three or more conductive layers with plated-through holes with or without stiffeners.
- Type 4. Multilayer rigid and flexible material combinations containing three or more conductive layers with plated-through holes.
- Type 5. Flexible or Rigid-Flex printed wiring containing two or more conductive layers without plated-through holes.

The types referred to in this section on flexible and rigid-flex printed wiring will use the definitions above.

The physical requirements for Folding Flexibility and Flexibility Endurance are not described in this document. If required by the procurement documentation, refer to IPC-6013 for details.

4.1 FLEXIBLE AND RIGID-FLEX PRINTED WIRING

4.1.1 Coverlayer Coverage – Coverfilm Separations

Imperfections such as wrinkles, creases, and nonlamination are acceptable provided they do not exceed the limits below and foreign inclusions are per this document.

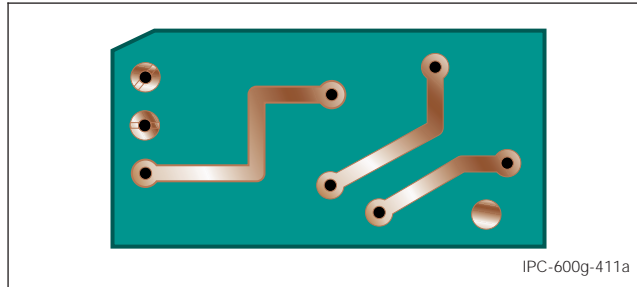

Target Condition – Class 1, 2, 3

- Uniform and no separations or delamination.
- No wrinkles, creases or soda strawing.

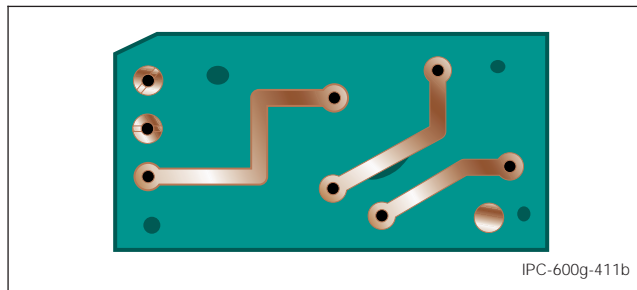

Acceptable – Class 1, 2, 3

Delamination and nonlamination **shall** meet the following criteria:

- At random locations away from conductors, each separation is no larger than 0.80 mm x 0.80 mm [0.0315 in x 0.0315 in] and is not within 1.0 mm [0.0394 in] of the board edge or the coverfilm opening.
- The total number of separations does not exceed three in any 25 mm x 25 mm [0.984 in x 0.984 in] of coverfilm surface area.
- The total separation does not exceed 25% of the spacing between adjacent conductors.
- No coverfilm nonlamination along the outer edges of the coverfilm.

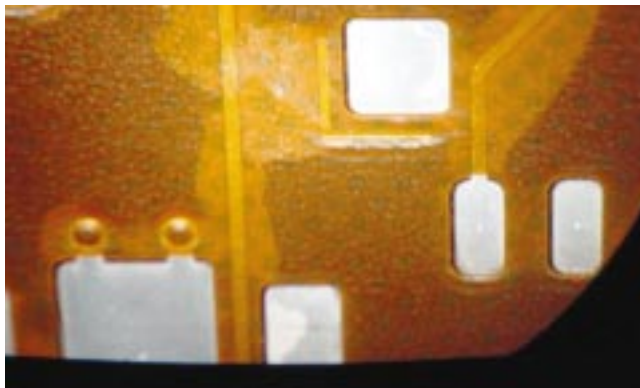

Nonconforming – Class 1, 2, 3

- Defects exceed above criteria.

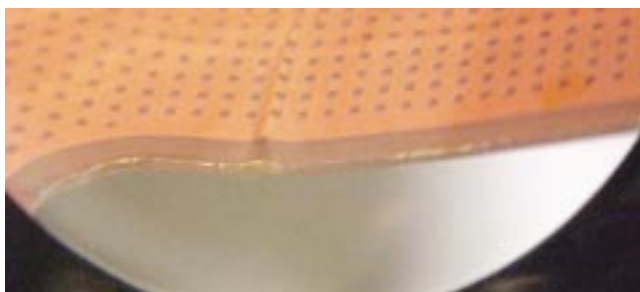

4.1 FLEXIBLE AND RIGID-FLEX PRINTED WIRING

4.1.2 Coverlayer/Cover Coat Coverage – Adhesives

The cover coat coverage **shall** have the same requirements as the solder resist (soldermask) coatings in the rigid board section of this document. The section covers the acceptability requirements for coverlayer coverage including squeeze-out of adhesive over the solderable land area and foil surface.

4.1.2.1 Adhesive Squeeze-Out – Land Area

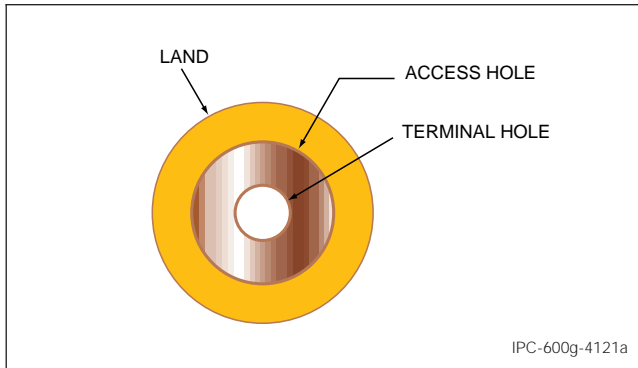

Target Condition – Class 1, 2, 3

- No unwanted material on land area.

Acceptable – Class 3

- A 0.05 mm [0.00197 in] solderable annular ring for 360° of the circumference.

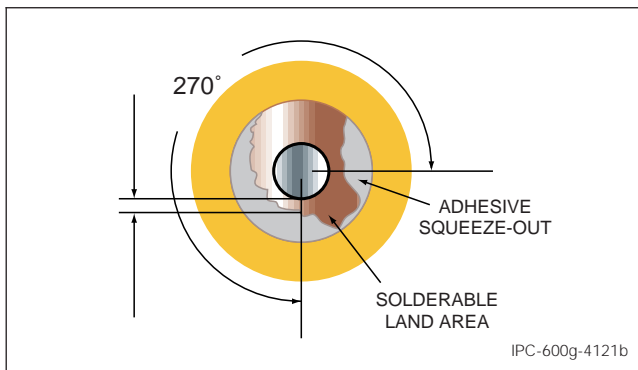

Acceptable – Class 2

- A 0.05 mm [0.00197 in] solderable annular ring for at least 270° of the circumference.

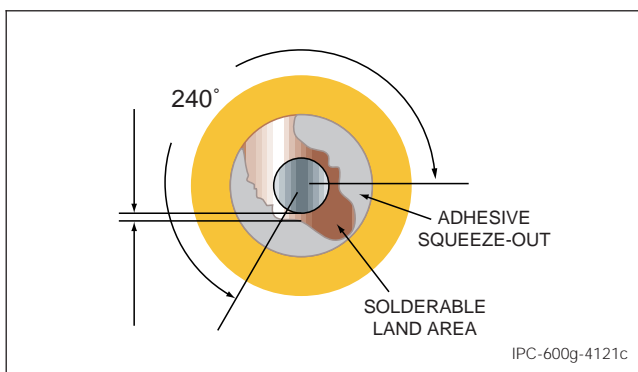

Acceptable – Class 1

- A solderable annular ring for at least 240° of the circumference.

Nonconforming - Class 1, 2, 3

- Defects either do not meet or exceed above criteria.

4.1 FLEXIBLE AND RIGID-FLEX PRINTED WIRING

4.1.2.2 Adhesive Squeeze-Out – Foil Surface

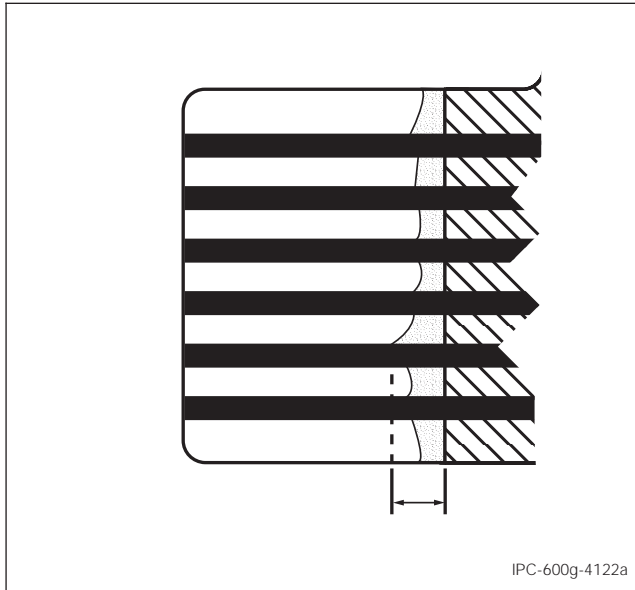

Target Condition - Class 1, 2, 3

- No unwanted material on foil surface.

Acceptable - Class 3

70 μm Foil and Below:

- ≤ 0.2 mm [0.0079 in].

Above 70 μm Foil

- ≤ 0.4 mm [0.0157 in] or as agreed upon with the manufacturer.

Acceptable - Class 1, 2

70 μm Foil and Below:

- ≤ 0.3 mm [0.0118 in].

Above 70 μm Foil

- ≤ 0.5 mm [0.0197 in] or as agreed upon with the manufacturer.

Nonconforming - Class 1, 2, 3

- Defects exceed above criteria.

4.1.3 Access Hole Registration for Coverlayer and Stiffeners

In cases where anchoring spurs are attached to the lands, they **shall** be lapped by the coverlayer.

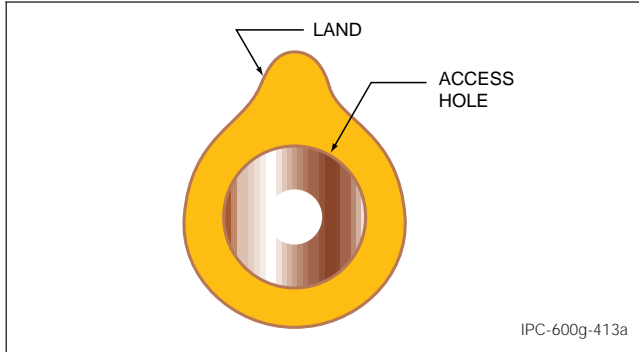

Target Condition – Class 1, 2, 3

- Meets nominal registration.

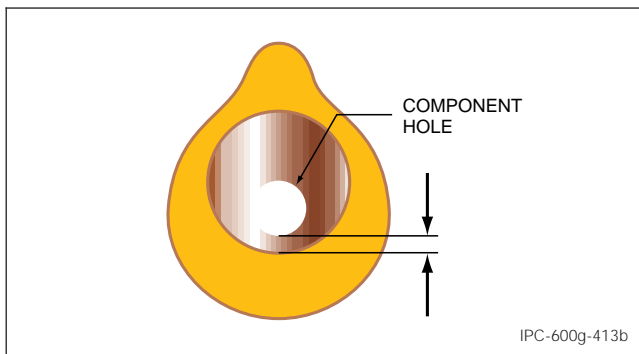

Acceptable – Class 3

- Coverlayer or stiffener does not extend into the hole.
- For supported holes, a solderable annular ring of 0.05 mm [0.00197 in] or more for the full circumference.
- For unsupported holes, a solderable annular ring of 0.25 mm [0.00984 in].

Acceptable – Class 2

- Coverlayer or stiffener does not extend into the hole.
- A solderable annular ring for 270° or more of the circumference.

Acceptable – Class 1

- Coverlayer or stiffener does not extend into the hole.
- A solderable annular ring for 180° or more of the circumference.

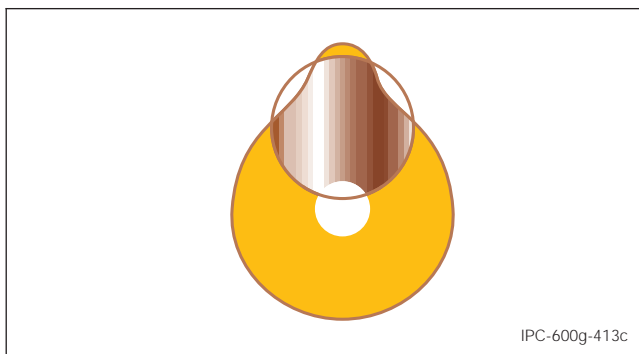

Nonconforming - Class 1, 2, 3

- Defect exceeds above criteria.

4.1 FLEXIBLE AND RIGID-FLEX PRINTED WIRING

4.1.4 Plating Defects

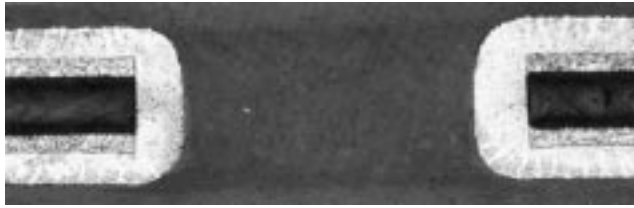

Target Condition – Class 1, 2, 3

- Plating is uniform and meets the minimum thickness requirements.
- No defects of the plating or base material present.

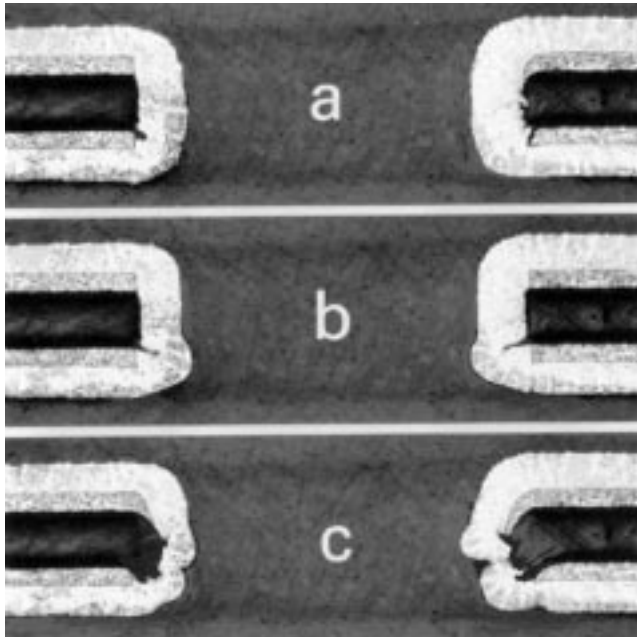

Acceptable – Class 1, 2, 3

- Minor defects present but meet the minimum requirements:
 - a. Slight deformation of base material and minor smear.
 - b. Adhesive or dielectric filament with small nodule, but copper thickness meets minimum requirements.
 - c. Localized thin and nonuniform plating; copper slightly thin over one corner and minor extrusion of base material, but copper thickness meets minimum requirements.
 - d. Adhesive filament does not cause cracks in plating.
 - e. Nodules, extrusion and deformation of base material do not violate minimum hole size requirements.
 - f. Plating does not violate the minimum thickness requirement.
 - g. No circumferential voids.

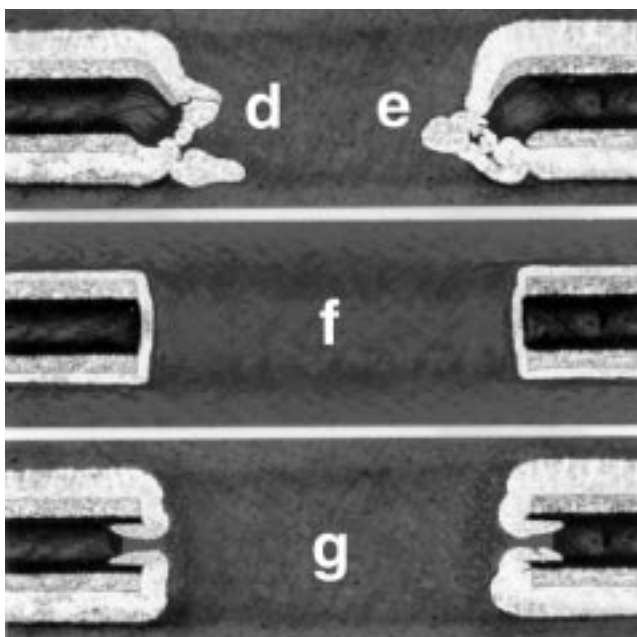

Nonconforming – Class 1, 2, 3

- Defects exceed above criteria.

4.1 FLEXIBLE AND RIGID-FLEX PRINTED WIRING

4.1.5 Stiffener Bonding

The stiffener is evaluated for mechanical support only by way of the test method listed below.

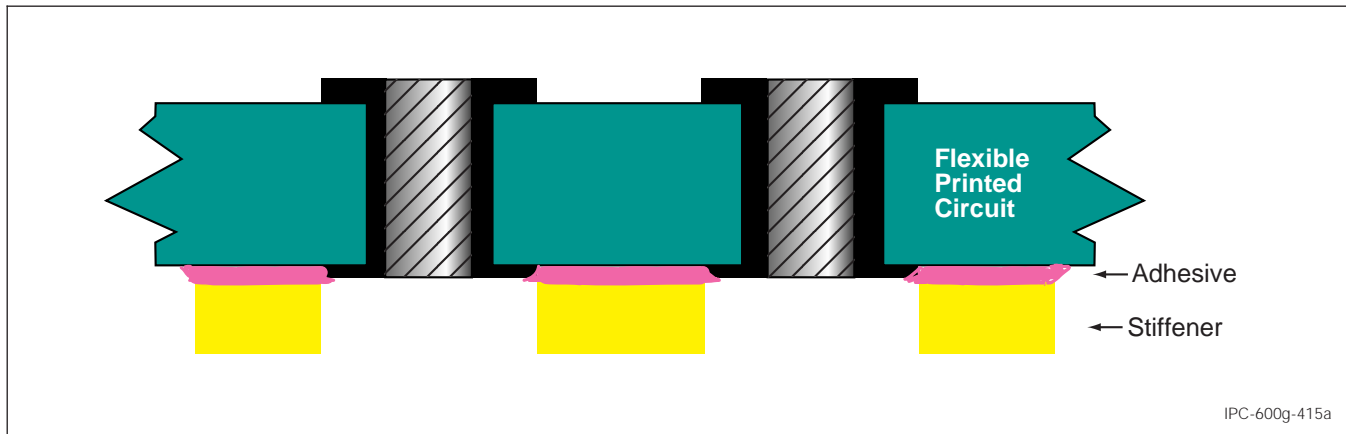

Acceptable – Class 1, 2, 3

- Mechanical support is required; void-free bonding is not required.
- The stiffener or adhesive used to bond the stiffener does not reduce the solderable annular ring below the minimum solderable annular ring requirements.
- Voids in the stiffener adhesive.
- Peel strength of the bond is a minimum of 0.055 kg/mm width when tested as follows:

Test Method: Using a sharp instrument such as a scalpel or razor blade, cut approximately 10 mm [0.394 in] wide by 80 mm [3.15 in] long through the flexible wiring to the stiffener so that approximately half way through the peeling operation the sample will be perpendicular to the pull. Pull at a rate of 50 ± 6.3 mm/minute. Take readings at the beginning, middle, and end of the pull, and average the reading for acceptability. The peel strength between the flexible wiring and the stiffener **shall** be a minimum of 0.055 kg/mm width.

Nonconforming - Class 1, 2, 3

- Defects exceed above criteria.

4.1 FLEXIBLE AND RIGID-FLEX PRINTED WIRING

4.1.6 Transition Zone, Rigid Area to Flexible Area

The transition zone is the area centered at the edge of the rigid portion from which the flexible portion extends. The inspection range is limited to 3 mm [0.12 in], about the center of the transition, which is the edge of the rigid portion.

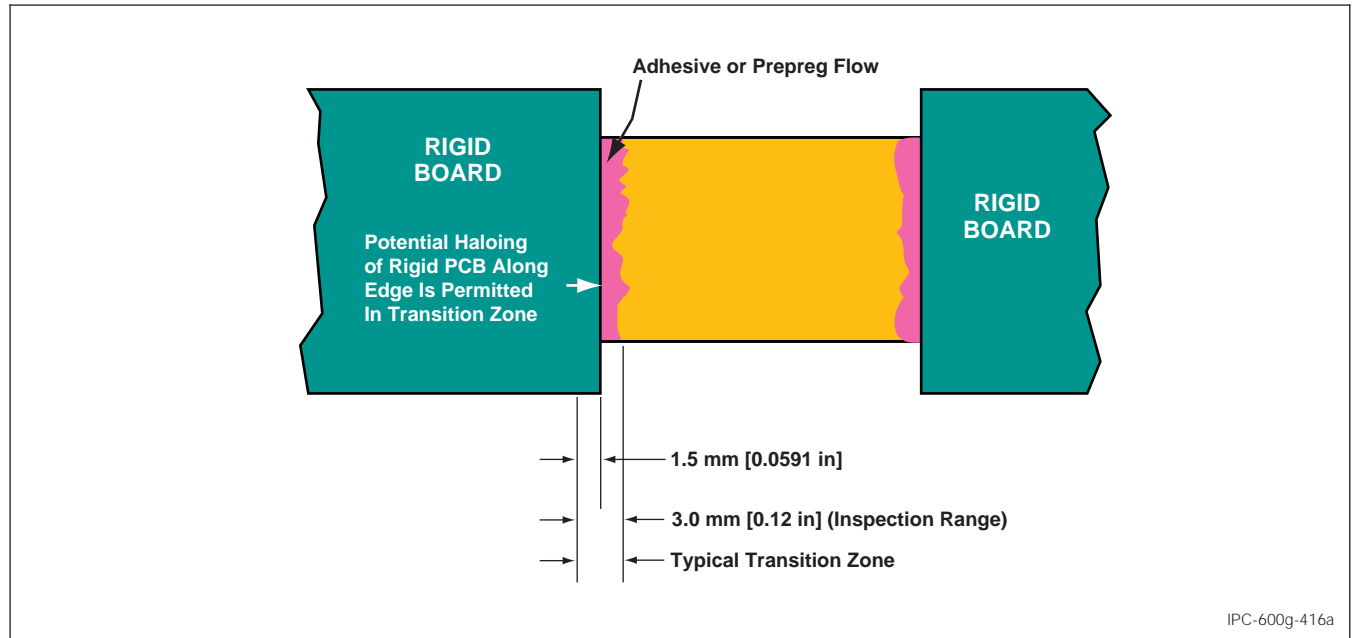

Acceptable - Class 1, 2, 3

- Adhesive squeeze-out.
- Localized deformation of dielectric or conductors.
- Protruding dielectric material.

Nonconforming - Class 1, 2, 3

- Defects exceed above criteria.

4.1.7 Solder Wicking/Plating Migration Under Coverlayer

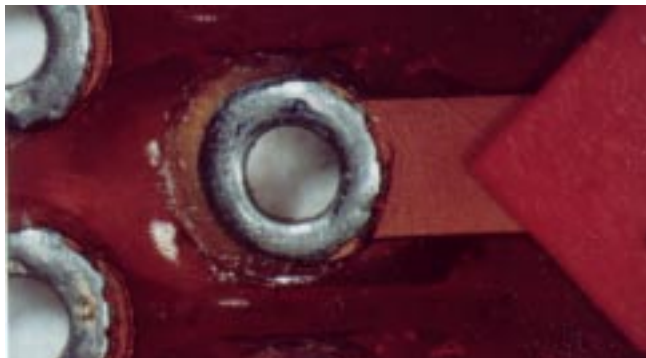
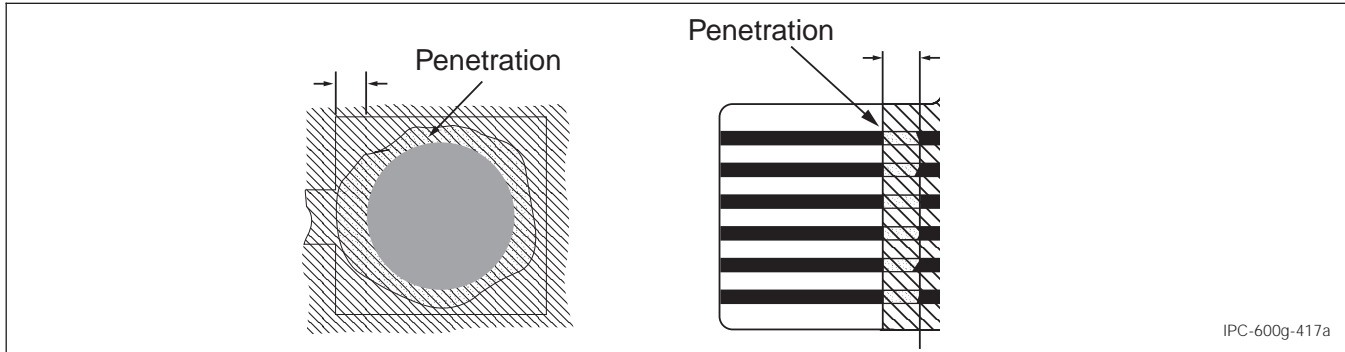

Target Condition – Class 1, 2, 3

- Solder or plating on land covers all exposed metal and stops at coverlayer.
- Solder wicking or plating migration does not extend into the bend or flex transition area.

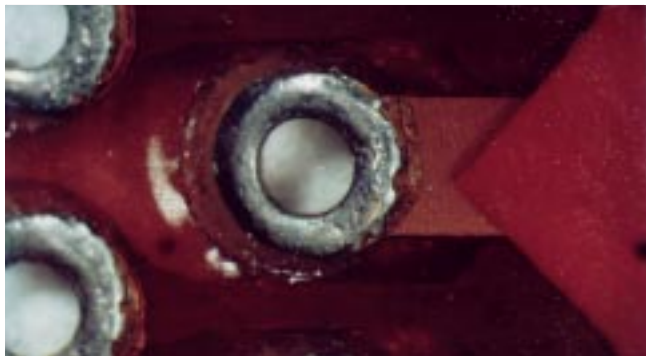

Acceptable – Class 3

- Solder wicking/plating migration does not extend under coverlayer more than 0.3 mm [0.012 in].
- Solder wicking or plating migration does not extend into the bend or flex transition area.
- Meets conductor spacing requirements.

Acceptable – Class 2

- Solder wicking/plating migration does not extend under coverlayer more than 0.5 mm [0.020 in].
- Solder wicking or plating migration does not extend into the bend or flex transition area.
- Meets conductor spacing requirements.

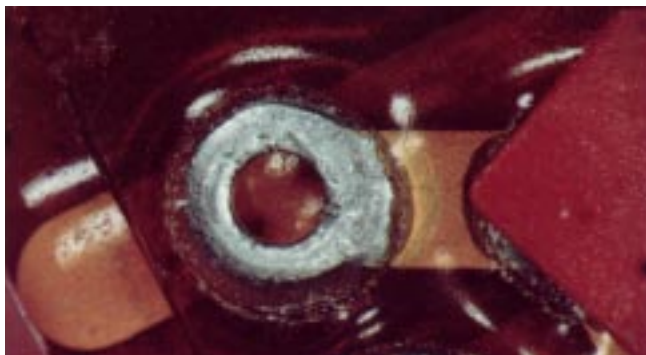

Acceptable – Class 1

- As agreed upon between user and supplier.
- Solder wicking or plating migration does not extend into the bend or flex transition area.
- Meets conductor spacing requirements.

Nonconforming - Class 1, 2, 3

- Defects exceed above criteria.

4.1 FLEXIBLE AND RIGID-FLEX PRINTED WIRING

4.1.8 Laminate Integrity

This section shows the voids and cracks that may be present in flexible or rigid-flex printed wiring. The requirements for the flexible printed wiring portion differs from the rigid-flex printed wiring and is defined in the text even though only a rigid-flex section is shown.

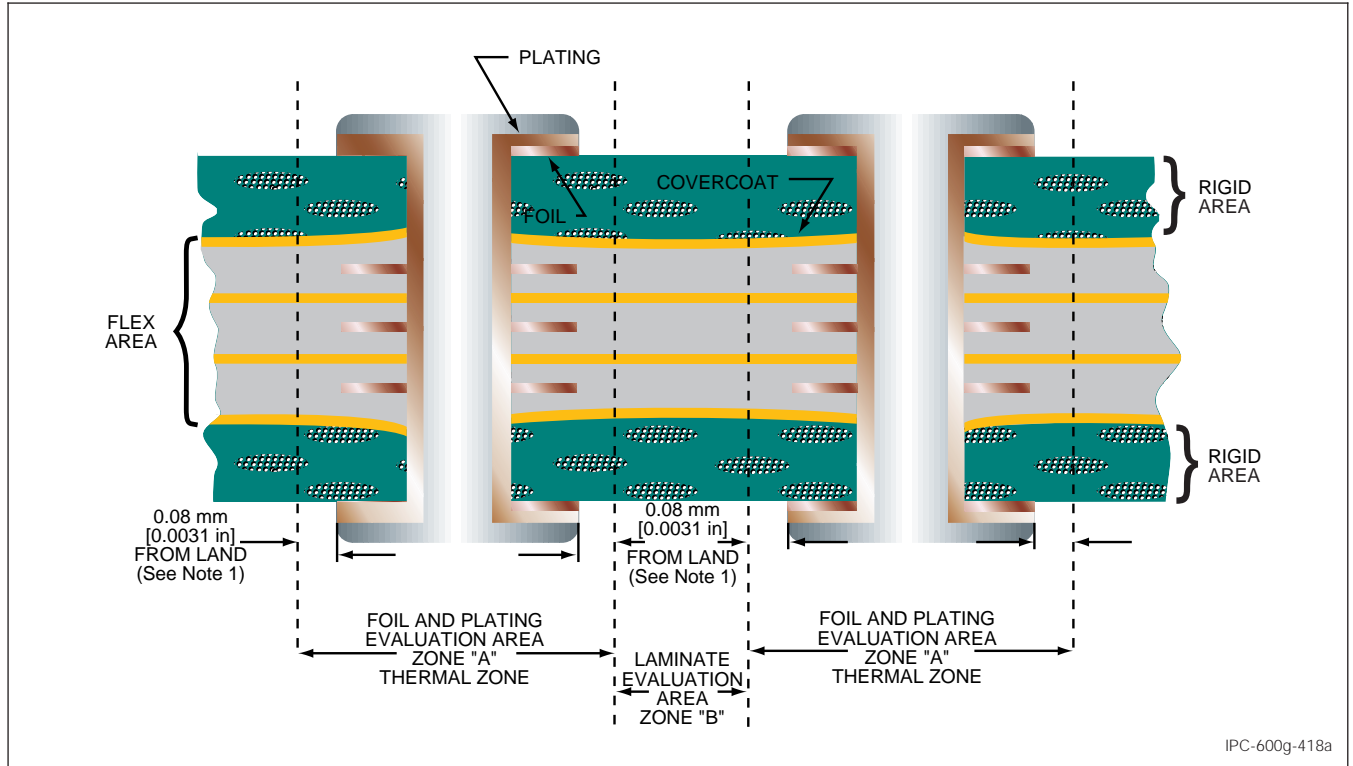

- Notes:**
1. The thermal zone extends 0.08 mm [0.0031 in] beyond land edge, internal or external, that is most radially extended.
 2. Laminate anomalies or imperfections in Zone A areas are not evaluated on specimens which have been exposed to thermal stress or rework simulation.
 3. Multiple voids or cracks between plated-through holes in the flex area and in the same plane **shall not** have combined length exceeding the limit.

Target Condition

- No laminate voids or cracks.

4.1.8.1 Laminate Integrity - Flexible Printed Wiring

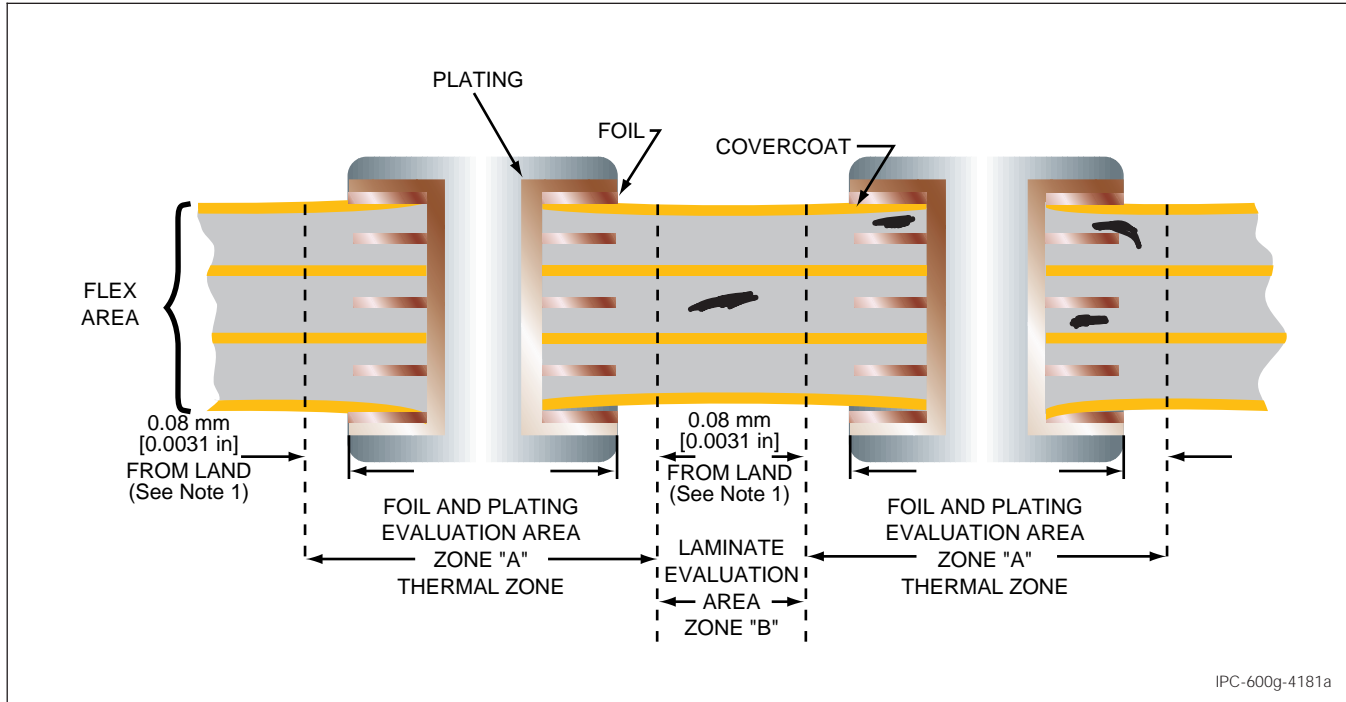

Target Condition

- No laminate voids or cracks.

Acceptable - Class 1, 2, 3

- Laminate voids or cracks are not evaluated in Zone A.
- Laminate voids or cracks in flexible printed wiring do not exceed 0.50 mm [0.020 in] in Zone B.

Nonconforming - Class 1, 2, 3

- Defects exceed above criteria.

- Notes:**
1. The thermal zone extends 0.08 mm [0.0031 in] beyond land edge, internal or external, that is most radially extended.
 2. Multiple voids or cracks between plated-through holes and in the same plane **shall not** have combined length exceeding the limits for all classes.

4.1.8.2 Laminate Integrity - Rigid-Flex Printed Wiring

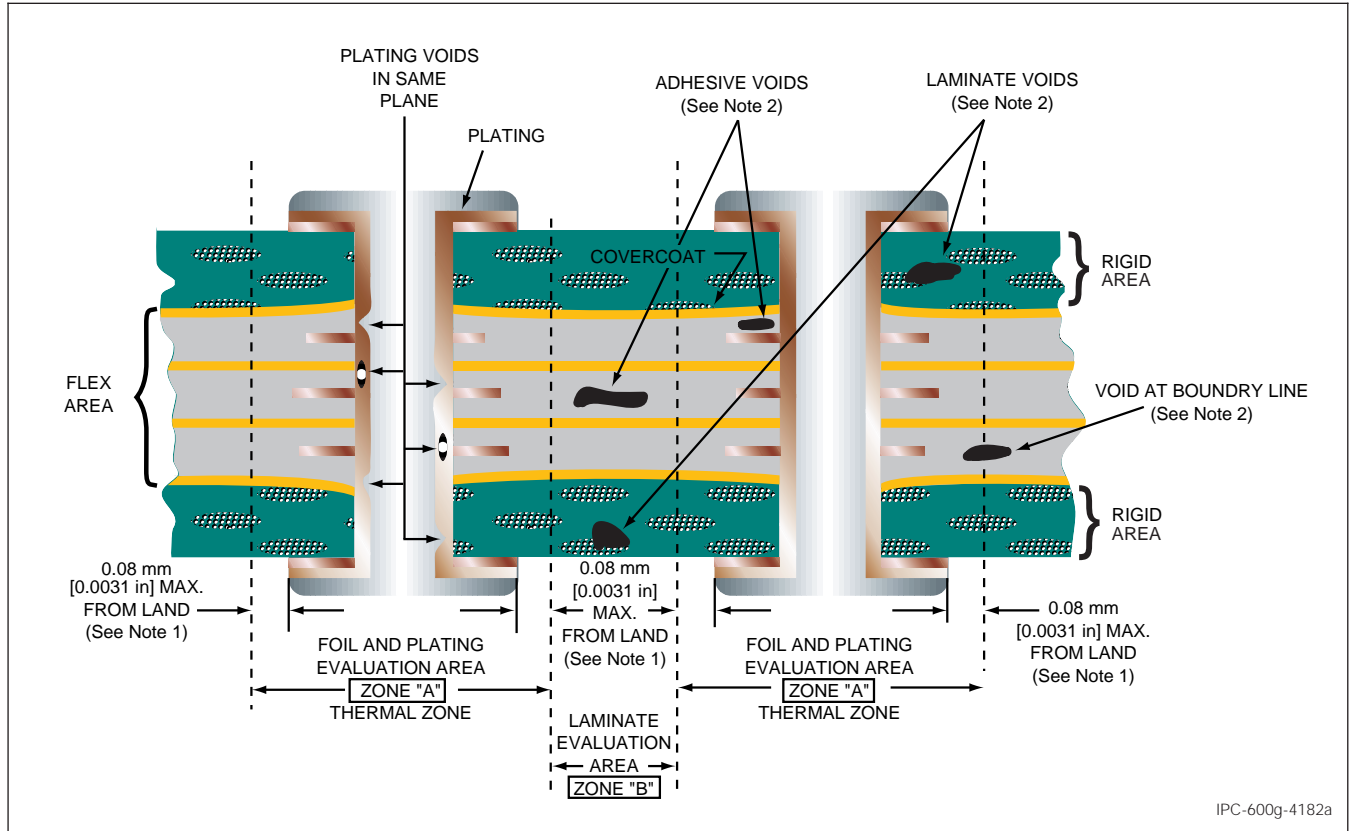

IPC-600g-4182a

Target Condition

- No laminate voids or cracks.

Acceptable - Class 2, 3

- Laminate voids or cracks are not evaluated in Zone A.
- Laminate voids or cracks in the rigid portion of rigid-flex printed wiring are not in excess of 0.08 mm [0.0031 in] in Zone B.
- Laminate voids or cracks in the flexible portion of rigid-flex printed wiring are not in excess of 0.5 mm [0.020 in] in Zone B.

Acceptable - Class 1

- Laminate voids are not evaluated in Zone A.
- Laminate voids or cracks in the rigid-flex portion of rigid-flex printed wiring are not in excess of 0.15 mm [0.00591 in] in Zone B.

Nonconforming - Class 1, 2, 3

- Defects exceed above criteria.

- Notes:**
1. The thermal zone extends 0.08 mm [0.0031 in] beyond land edge, internal or external, that is most radially extended.
 2. Multiple voids or cracks between plated-through holes in the flex area and in the same plane **shall not** have combined length exceeding the limits for all classes.

4.1 FLEXIBLE AND RIGID-FLEX PRINTED WIRING

4.1.9 Etchback (Type 3 and Type 4 Only)

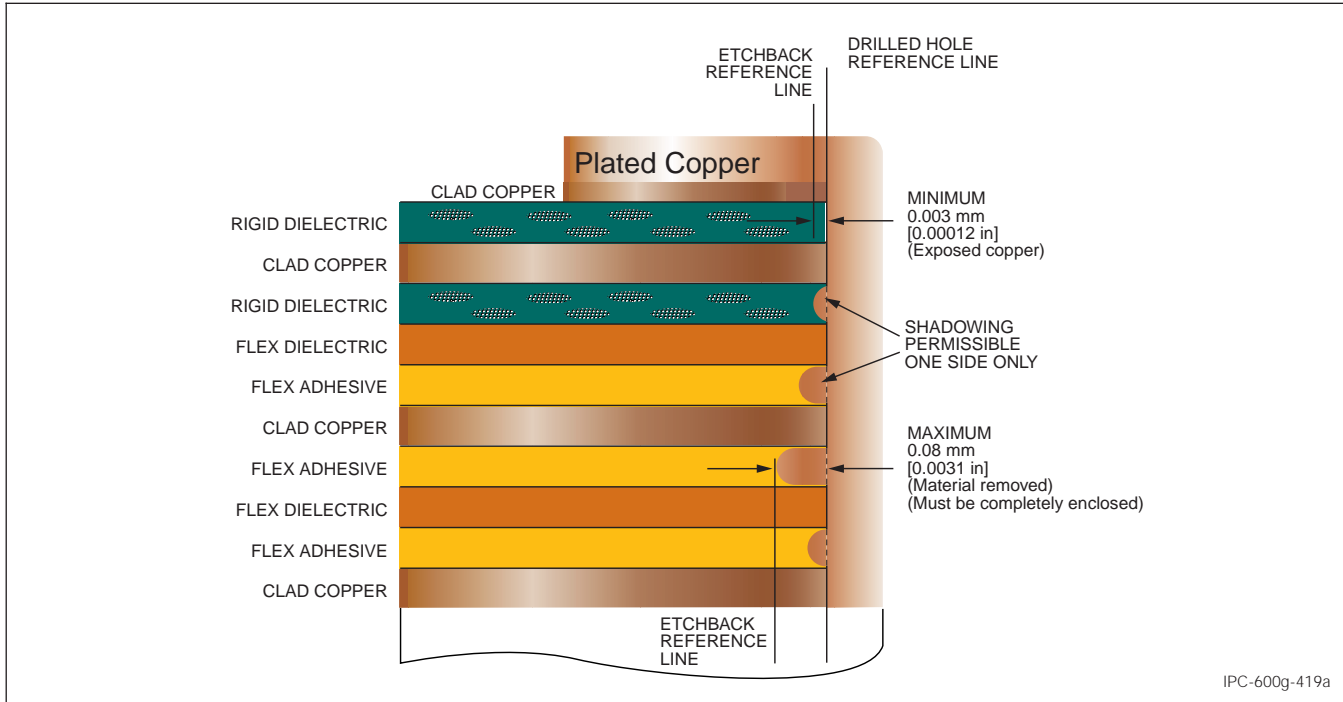

Target Condition/Acceptable - Class 1, 2, 3

- Etchback between 0.003 mm [0.00012 in] and 0.08 mm [0.0031 in].
- Shadowing permitted on one side of each land.

Nonconforming - Class 1, 2, 3

- Defects exceed above criteria.

Note: Due to various materials used in the construction of rigid-flex printed wiring, varying degrees of preferential etchback is exhibited among the various materials.

4.1 FLEXIBLE AND RIGID-FLEX PRINTED WIRING

4.1.10 Smear Removal (Type 3 and 4 Only)

Smear removal is the removal of debris that results from the formation of the hole. Smear removal should be sufficient to completely remove resin from the surface of conductor interface.

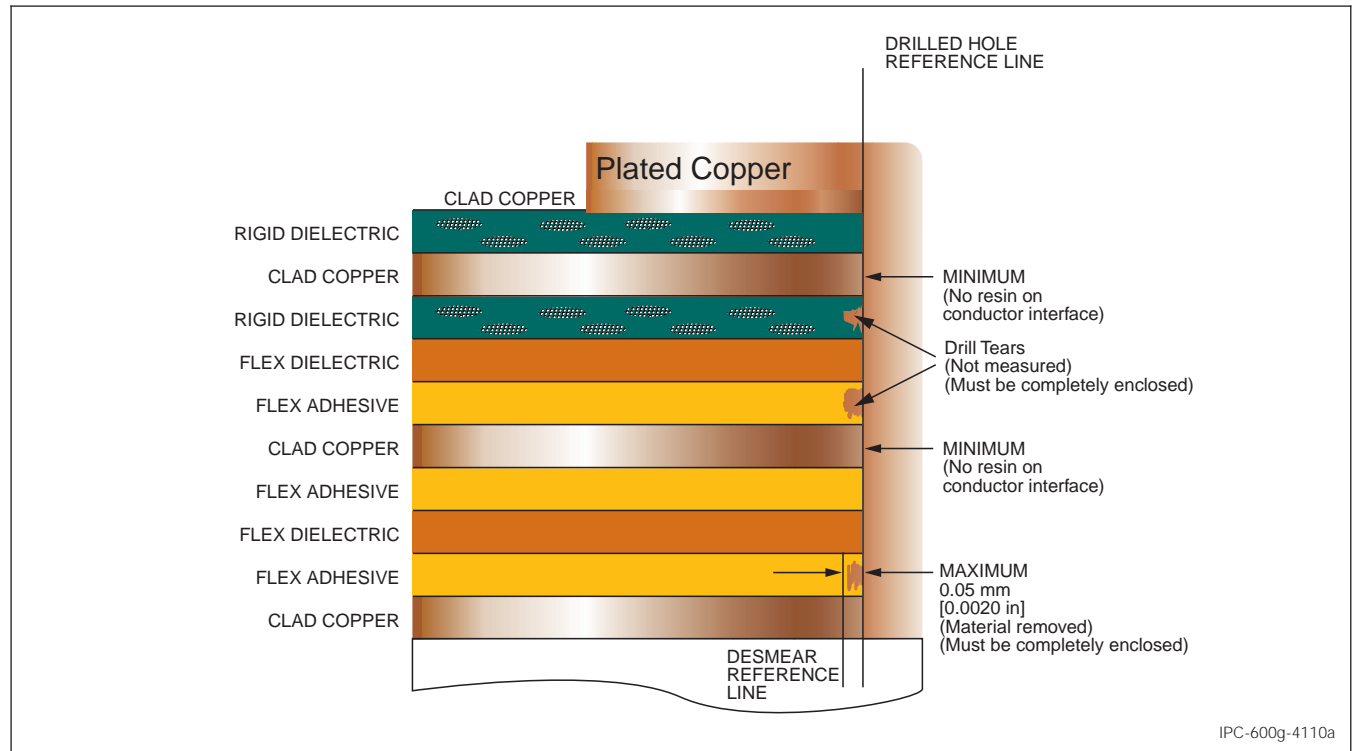

Target Condition/Acceptable - Class 1, 2, 3

- Smear removal process **shall not** etchback more than 0.025 mm [0.001 in].
- Random tears or gouges that produce small areas where the 0.025 mm [0.001 in] depth is exceeded provided dielectric spacing is maintained.
- Smear removal sufficiently meets the acceptability criteria for plating separation (see 3.3.13).

Nonconforming - Class 1, 2, 3

- Defects exceed above criteria.

4.1 FLEXIBLE AND RIGID-FLEX PRINTED WIRING

4.1.11 Trimmed Edges/Edge Delamination

The trimmed edge of the flexible printed wiring or the flexible section rigid-flex printed wiring **shall** be free of burrs, nicks, delamination, or tears in excess of that allowed in the procurement documentation. Minimum edge to conductor **shall** be specified in the procurement documentation.

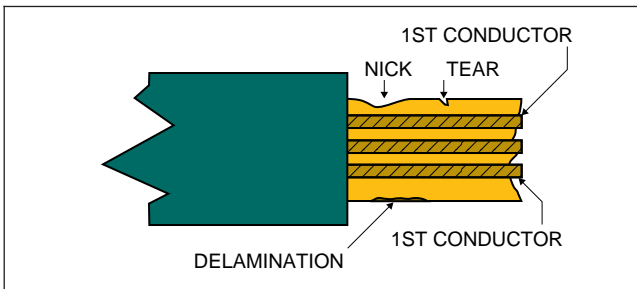
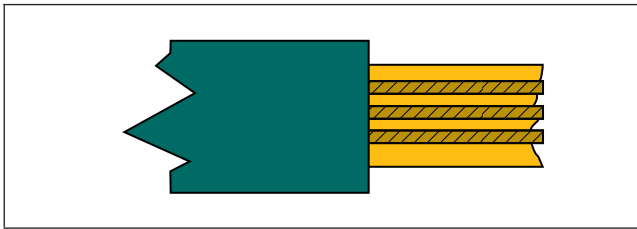

Target Condition – Class 1, 2, 3

- Free of nicks and tears. Minimum edge to conductor spacing maintained.
- The trimmed edge of the flexible printed wiring or the flexible section of finished rigid-flex printed wiring is free of burrs, nicks, delamination, and tears.

Acceptable – Class 1, 2, 3

- No nicks or tears in excess of that specified in the procurement documentation.
- Nicks and tears that occur as a result of tie-in tabs to facilitate circuit removal **shall** be as agreed on by the user and supplier.
- Edge to conductor spacing of the flexible portion is within requirements specified on the procurement documentation.
- Nicks or halos along the edges of the flexible printed wiring, cutouts, and unsupported holes, providing the penetration does not exceed 50% of the distance from the edge to the nearest conductor or more than 2.5 mm [0.0984 in], whichever is less.

Acceptable - As agreed by user and supplier

- When nicks and tears occur as a result of tie-in tabs to facilitate circuit removal, the extent of these imperfections do not exceed the requirements agreed to by user and supplier.

Nonconforming - Class 1, 2, 3

- Defects exceed above criteria.

4.2 METAL CORE PRINTED BOARDS

Introduction

There are two types of metal core boards, both having one or more conductive patterns on each side of an insulated metal substrate. Interconnection between conductive patterns is made with plated-through holes.

In the first type, for double-sided boards, the metal core is laminated on each side with single-sided copper clad laminate to form a two-sided board with the conductors subsequently etched and plated by conventional printed board processes. For multilayer applications, additional etched internal layers may be laminated to the core or multiple cores. The cores may serve as a heat sink, a power or ground plane, or as a constraining plane to decrease the coefficient of thermal expansion (CTE) of the board in the planar direction.

For this type, the cores are commonly aluminum, copper, or (for CTE control), copper clad invar or molybdenum. If the cores are not to be electrically connected to the circuitry (as is normally the case with aluminum cores), clearance holes for plated-through holes are drilled or punched prior to lamination and filled with an insulating material. Copper cores may be electrically connected through the plated-through hole. However, copper clad invar or molybdenum requires special processing to make acceptable electrical connections.

In the second type of metal core board, clearance holes are drilled, punched or machined in the bare core and it is then coated with an insulating material by spray coating, electrophoretic processes, or fluidized bed techniques. The coating must be pinhole free and of the specified thickness required to withstand electrical leakage and arc-over. After coating, the insulation is covered with electroless copper and plated and etched to provide required surface conductors and plated-through holes. For this type, the core may be copper, aluminum or steel, and most often acts as a heat sink or stiffener.

4.2 METAL CORE PRINTED BOARDS

4.2.1 Type Classifications

Metal Core Board Types

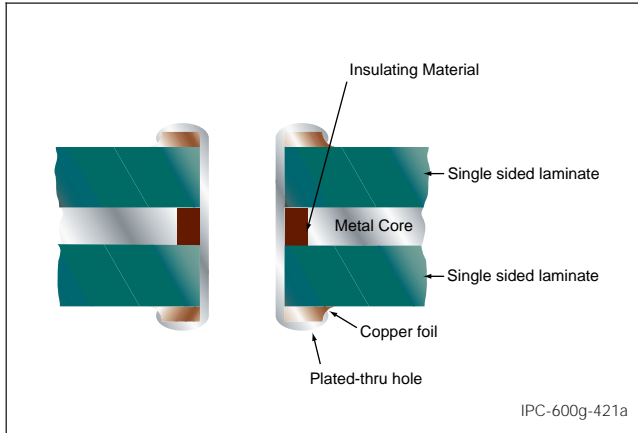

Laminated Type Metal Core Board

- Single conductive layer on both sides and insulated from the metal core substrate. Conductive material to be copper foil and electrodeposited copper.

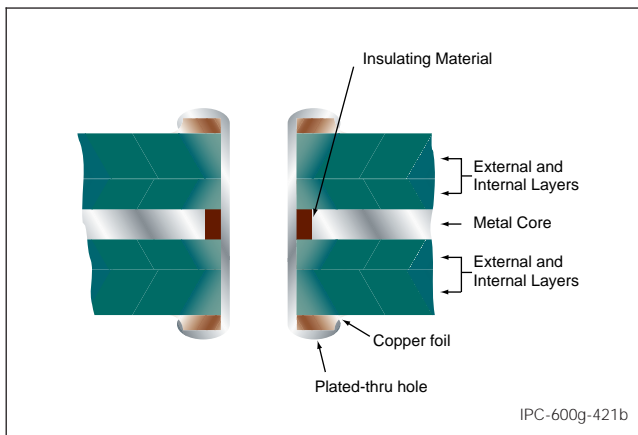

Laminated Type Metal Core Multilayer Board

- More than one conductive layer on one or both sides and insulated from the metal core substrate. Conductive material to be copper foil and electrodeposited copper.

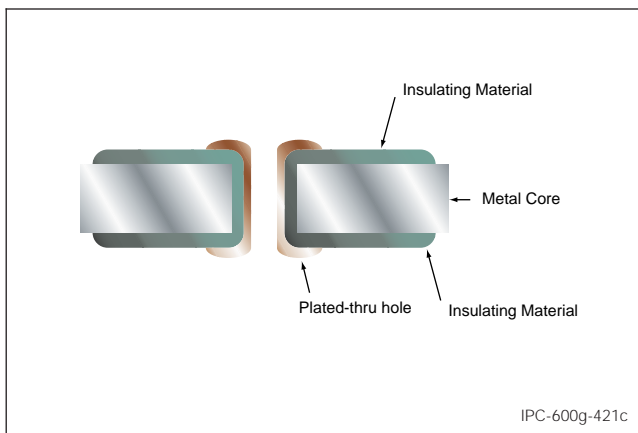

Insulated-Metal-Substrate Metal Core Board

- Single conductive layer on both sides and insulated from the metal core substrate. Conductive material to be electroless copper and a copper flash is then applied over all surfaces. From this point on, document printed board fabrication processes are employed. This process is generally limited to double-sided boards only.

4.2 METAL CORE PRINTED BOARDS

4.2.2 Spacing Laminated Type

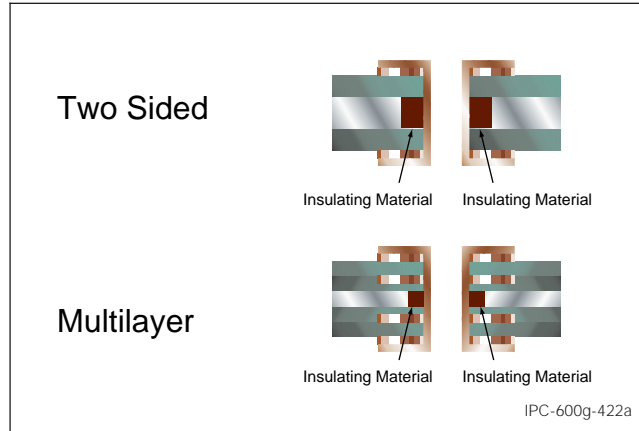

Target Condition – Class 1, 2, 3

- The spacing between the metal core and adjacent conductive surfaces exceeds 0.1 mm [0.0040 in].

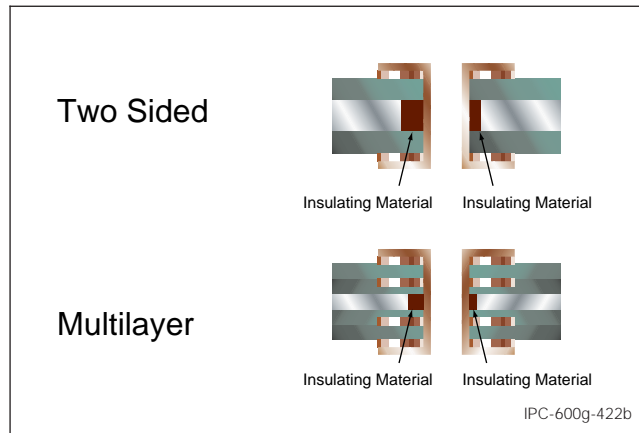

Acceptable – Class 1, 2, 3

- The spacing between the metal core and the plated-through hole or the metal core and adjacent conductive surfaces is greater than 0.1 mm [0.0040 in].

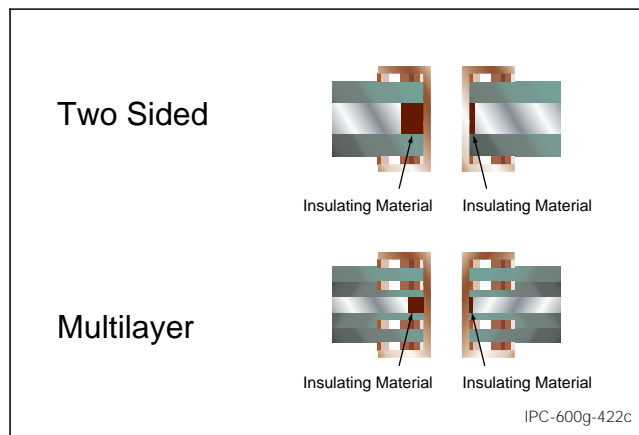

Nonconforming – Class 1, 2, 3

- Defects exceed above criteria.

4.2 METAL CORE PRINTED BOARDS

4.2.3 Insulation Thickness, Insulated Metal Substrate

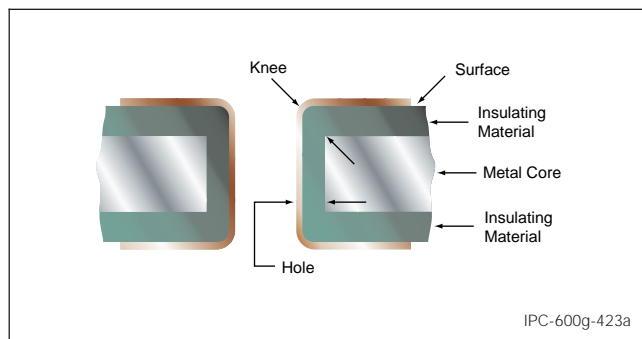

Target Condition – Class 1, 2, 3

- Insulation thickness exceeds requirements of the table below.

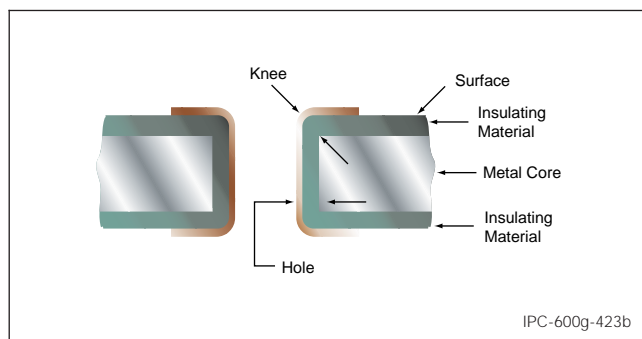

Acceptable – Class 1, 2, 3

- Insulation thickness meets requirements of the table below.

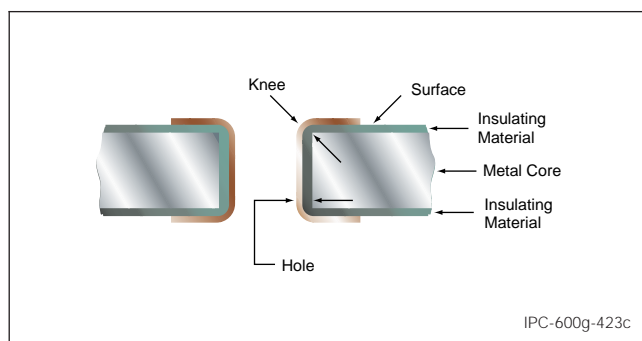

Nonconforming – Class 1, 2, 3

- Defects exceed above criteria.

Description	Insulation Process*			
	A	B	C	D
Hole (minimum)	0.050 mm [0.0020 in]	0.025 mm [0.000984 in] - 0.065 mm [0.00256 in]	0.125 mm [0.004921 in]	0.125 mm [0.004921 in]
Surface (minimum)	0.050 mm [0.0020 in]	0.025 mm [0.000984 in] - 0.065 mm [0.00256 in]	0.125 mm [0.004921 in]	N/A
Knee** (minimum)	0.025 mm [0.000984 in]	0.025 mm [0.000984 in]	0.075 mm [0.00295 in]	N/A

*Applies to insulated-metal-substrate board only.

**Junction where the hole wall and surface meet.

Process A – Spray Coating

Process B – Electrophoretic Deposition

Process C – Fluidized Bed Process

Process D – Molding Process

4.2 METAL CORE PRINTED BOARDS

4.2.4 Insulation Material Fill, Laminated Type Metal Core

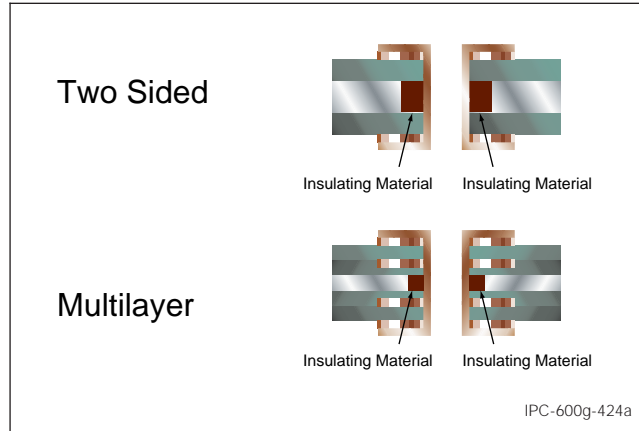

Target Condition – Class 1, 2, 3

- Insulation material fills the entire area between the plated-through hole and the metal core without any voids or areas of missing insulation.

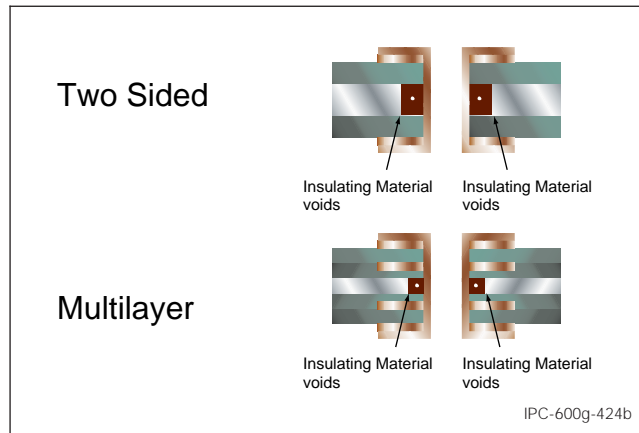

Acceptable – Class 1, 2, 3

- Insulating material meets minimum thickness and dielectric spacing requirements.
- Voids or resin recession does not cause spacing to be less than acceptability requirements.

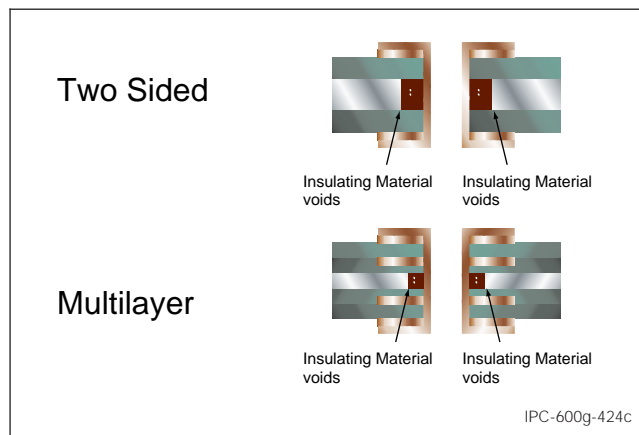

Nonconforming – Class 1, 2, 3

- Defects exceed above criteria.

4.2 METAL CORE PRINTED BOARDS

4.2.5 Cracks in Insulation Material Fill, Laminated Type

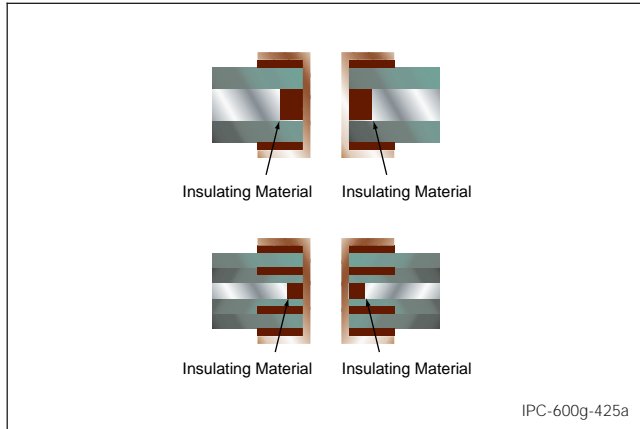

Target Condition – Class 1, 2, 3

- There are no cracks in the insulating fill material.

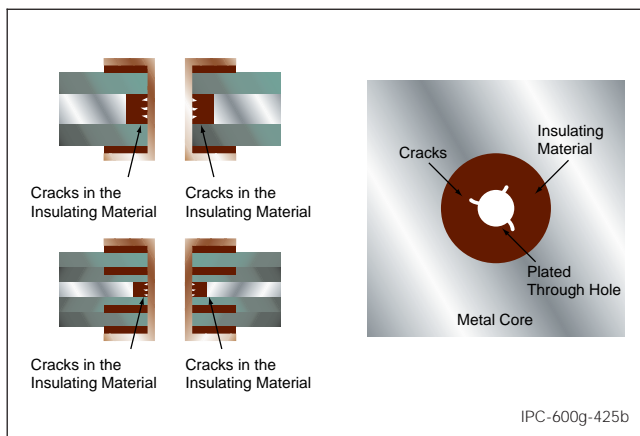

Acceptable – Class 1, 2, 3

- Wicking, radial cracks, lateral spacing or voids in the hole-fill insulation material **shall not** reduce the electrical spacing between adjacent conductive surfaces to less than 100 μm [0.003937 in].
- Wicking and/or radial cracks **shall not** exceed 75 μm [0.00295 in] from the plated-through hole edge into the hole-fill.

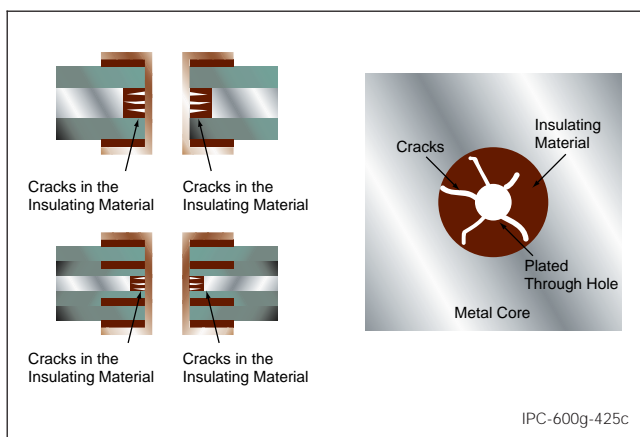

Nonconforming – Class 1, 2, 3

- Defects exceed above criteria.

4.2 METAL CORE PRINTED BOARDS

4.2.6 Core Bond to Plated-Through Hole Wall

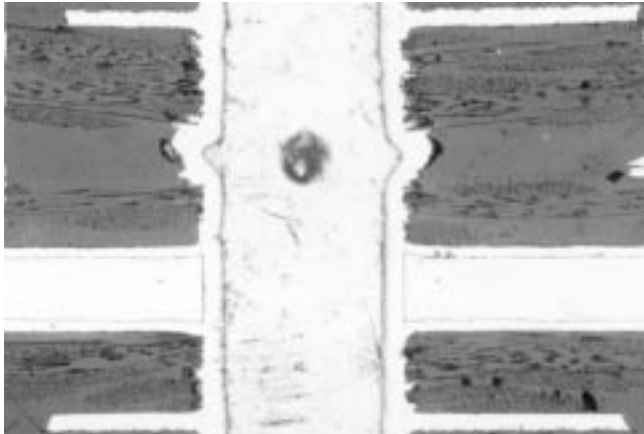

Target Condition – Class 1, 2, 3

- Complete bond on both sides.

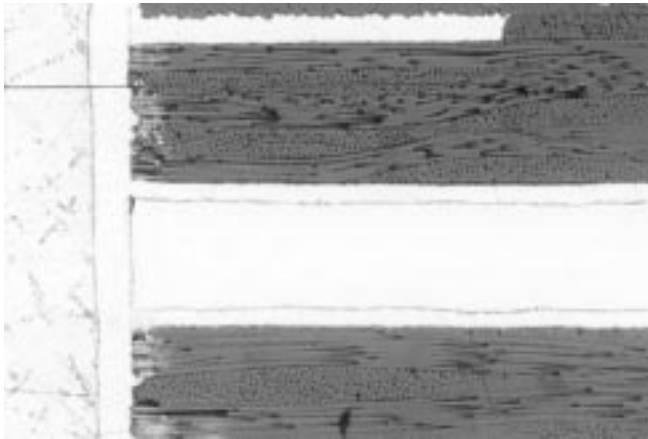

Acceptable – Class 1, 2, 3

- Interconnection separation not more than 50% of non-copper core thickness. If copper clad core is used it **shall not** have any separation in the copper portion of the interconnect.

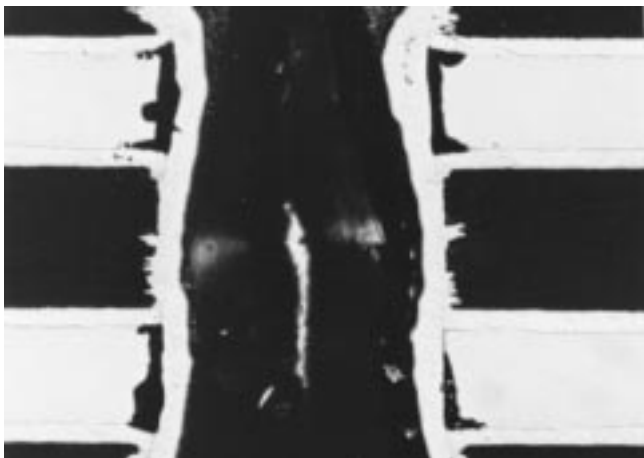

Nonconforming – Class 1, 2, 3

- Defects exceed above criteria.

4.3 FLUSH PRINTED BOARDS

Introduction

This section covers acceptability criteria for flush printed boards. In flush printed boards, the surfaces, holes and other parameters for acceptability are the same as in standard single- and double-sided printed boards. This section covers the additional parameters that are important to the evaluation of flush printed boards.

4.3.1 Flushness of Surface Conductor

The application of flush circuitry requires that the conductor surfaces and the base material be essentially in the same plane.

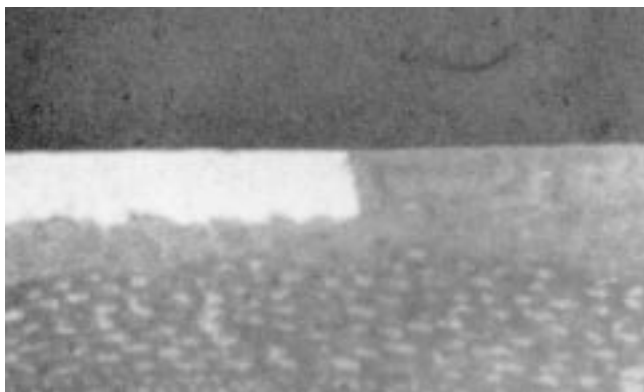

Target Condition – Class 1, 2, 3

- Conductor is flush to the base material or surrounding insulating material surface.

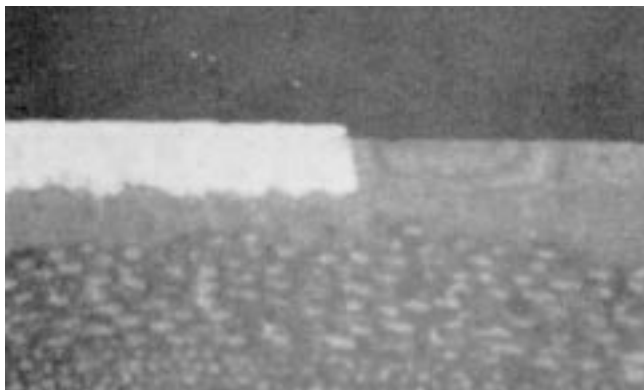

Acceptable – Class 1, 2, 3

- Conductor is not flush but meets the minimum requirements.

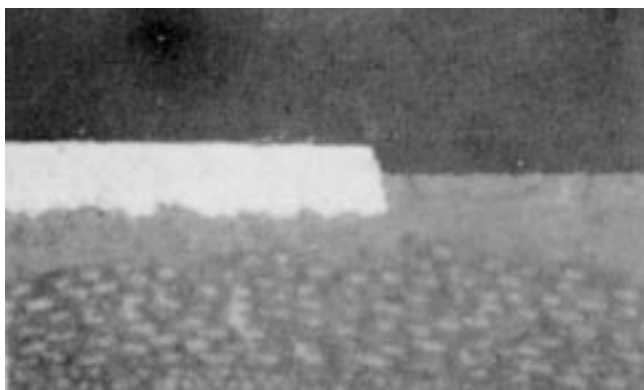

Nonconforming – Class 1, 2, 3

- Defects exceed above criteria.

5.0 CLEANLINESS TESTING

Introduction

The purpose of this section is to assist the reader in better understanding the importance of correct handling procedures in order to avoid damage and contamination during cleanliness testing.

The following general rules minimize surface contaminants when handling printed boards:

1. Work stations should be kept clean and neat.
2. There should be no eating, drinking or use of tobacco products at the work station or other activities that are likely to cause contamination of the board surfaces.
3. Hand creams and lotions containing silicone should not be used since they could result in solderability and other processing problems. Specially formulated lotions are available.
4. Handling of boards by their edges is desirable.
5. Lint free cotton or disposable plastic gloves should be used when handling bare boards. Gloves should be changed frequently as dirty gloves can cause contamination problems.
6. Unless special racks are provided, stacking boards without interleaving protection should be avoided.

Cleanliness testing is used to determine organic or inorganic, and ionizable or nonionizable contaminants.

The following are examples of the more common contaminants found on printed boards:

- | | |
|---------------------------|-----------------------|
| 1. Flux residues | 4. Fingerprints |
| 2. Particulate matter | 5. Corrosion (oxides) |
| 3. Chemical salt residues | 6. White residues |

Due to the destructive nature of contaminants, it is recommended that cleanliness requirements of applicable procurement documentation be adhered to.

The solvent resistivity **shall** be in accordance with IPC-6012 unless otherwise specified. The specimens **shall** be tested for ionic contamination in accordance with IPC-TM-650, Method 2.3.25 and 2.3.26.

5.1 SOLDERABILITY TESTING

Introduction

This section describes the methods and requirements for solderability testing. Solderability of printed boards verifies the state of the printed board expected during assembly. Solderability testing is performed on both the surface and plated-through holes. ANSI/J-STD-003 describes in detail the different solderability tests:

Test A – Edge Dip Test (for surface conductors and attachment lands only)

Test B – Rotary Dip Test (for plated-through holes, surface conductors and attachment lands, solder source side)

Test C – Solder Float Test (for plated-through holes, surface conductors and attachment lands, solder source side)

Test D – Wave Solder Test (for plated-through holes, surface conductors and attachment lands, solder source side)

Along with the solderability method, the user **shall** specify as part of the purchase order agreement, the required coating durability. The following are guidelines for determining the needed level of coating durability, not product performance classes. Accelerated aging and solderability testing **shall** be performed per ANSI/J-STD-003.

Coating Durability categories:

Category 1 – Minimum Coating Durability; intended for boards which will be soldered within 30 days from the time of manufacture and are likely to experience minimum thermal exposures.

Category 2 – Average Coating Durability; intended for boards likely to experience storage up to six months from the time of manufacture and moderate thermal or solder exposures.

Category 3 – Maximum Coating Durability; intended for boards likely to experience long storage (over six months) from the time of manufacture, and may experience severe thermal or solder processing steps, etc. It should be recognized that there may be a cost premium or delivery delay associated with boards ordered to this durability level.

The test specimen **shall** be a representative coupon as described in IPC-2221, a portion of the printed wiring board being tested, or a whole board if within size limits, such that a immersion depth defined in the individual method is possible. Sample holes should be selected at random.

5.1 SOLDERABILITY TESTING

5.1.1 Plated-Through Holes

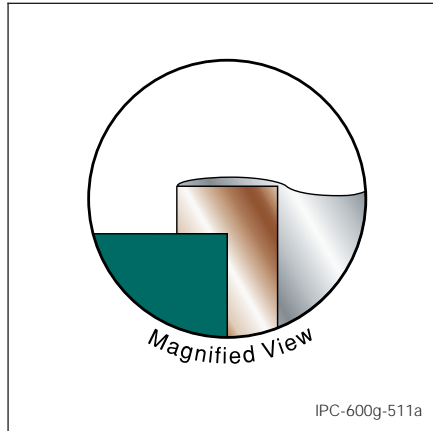

Target Condition – Class 1, 2, 3

- Solder has risen in all plated holes.
- There is no nonwetted or exposed base metal.

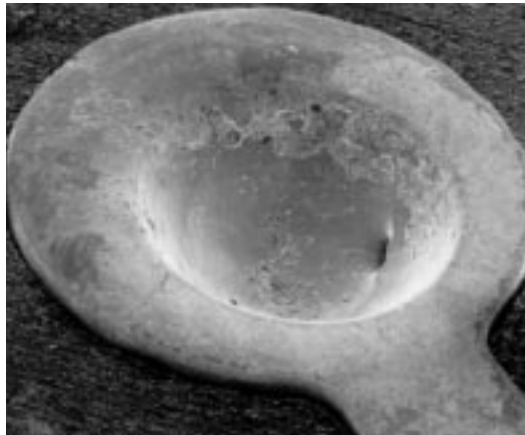
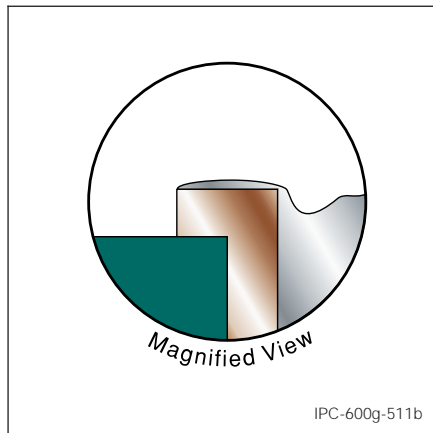

Acceptable – Class 1, 2, 3

- Solder has risen in all plated holes.
- There are several plugged holes less than 1.5 mm [0.0591 in] diameter.

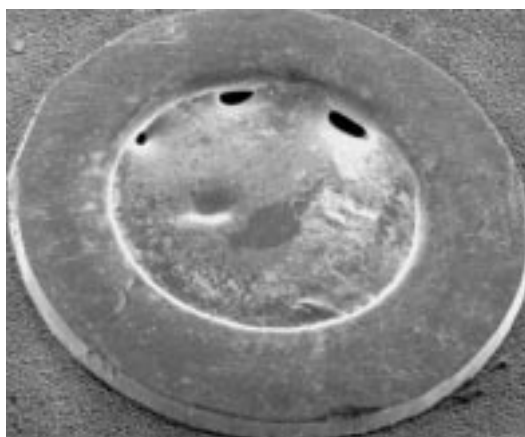
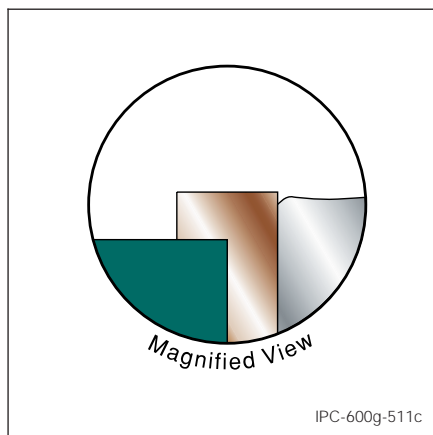

Nonconforming – Class 1, 2, 3

- Defects exceed above criteria.

5.2 ELECTRICAL INTEGRITY

Introduction

Testing of multilayer boards is required per IPC-6010 series unless otherwise specified or agreed upon by the customer.

Electrical Integrity: Inspection for the electrical functionability of the multilayer printed boards consists of:

- a. Checking continuity of all electrical conductors.
- b. Verify absence of short circuits.

Most of the interconnections in the printed boards are within the board structure and are not subject to visual inspection. Functional testing must be performed to determine the electrical integrity of all interconnections of the multilayer printed boards.

Basically, these functional electrical tests consist of ensuring existence of electrical continuity between specified lands and absence of internal shorts between individual electrical networks and ground power planes of the printed board. There are numerous techniques used to perform such testing, varying from manual probing to sophisticated automated procedures.

Continuity Testing: For circuit continuity testing a voltage is applied to two lands which should be interconnected and the presence or absence of current flow observed. The absence of current flow indicates an open circuit and a nonconformance. This process is repeated sequentially until all interconnections existing on a given board have been tested. Some specifications require a specified minimum current when the circuit is tested.

Internal Short Test: Testing procedures for the determination of absence of internal shorts are similar to the procedures described above for continuity testing. In this case the voltage is applied to a given internal ground plane, power plane or electrical network and all other lands are probed in sequence by applying voltage to them. A current flow between the energized land and the plane or network under test indicates an internal short and a nonconformance. This procedure is repeated for all internal planes and networks and all terminal areas of the multilayer board. Some specifications require that the testing for absence of shorts be performed by application of a high voltage source between the plane and terminal areas of 250 volts to 1000 volts (so called Hi-Pot testing) and note the absence of breakdown or flash-over. Some specifications specify a minimum resistance value which must exist between the unconnected lands and a given internal plane of the board. In such cases a suitable Megohm meter is used to perform the testing.

IPC-A-600 TRAINING AND CERTIFICATION PROGRAM

The IPC-A-600 *Acceptability of Printed Boards* document has set the standard for PWB workmanship quality. The IPC-A-600 has become one of the most widely recognized and used documents ever published by IPC. Now, an industry-consensus training and certification program based on the IPC-A-600 is available to your company. The IPC-A-600 Training and Certification Program helps all segments of the electronics interconnection industry improve their understanding of printed board quality issues.

HOW THE CERTIFICATION PROGRAM WORKS

The program follows a train-the-trainer model. Companies involved in fabrication, assembly, or original equipment manufacturers (OEMs) enroll a representative in a twenty-hour training course at any IPC-A-600 Approved Certification Center. The training program provides a detailed review of the IPC-A-600 criteria and concludes with a qualifying examination. Passing the exam means that "IPC-A-600 Certified Instructor/Inspectors" receive instructional materials to use in "Worker Proficiency" training. The operator-level Worker Proficiency course is "modularized," meaning that an Instructor/Inspector may teach the area(s) of the IPC-A-600 that are most relevant to the employees' responsibilities.

HOW TO REGISTER FOR INSTRUCTOR/INSPECTOR TRAINING

Contact these IPC-A-600 Approved Certification Centers to find out when their Instructor/Inspector Training Courses will be offered. For further information about the IPC-A-600 Instructor/Inspector Training and Certification Program, contact Lauren Davidson at 847/790-5314 or visit IPC on the web at www.ipc.org.

<p>American Competitiveness Institute(ACI)/Electronics Manufacturing Productivity Facility(EMPF) International Plaza One, Suite 600 Philadelphia, PA 19113 P: 610-362-1200 F: 610-362-1290 registrar@empf.org www.empf.org</p>	<p>Blackfox Training Institute, LLC 900 South Main, Suite 101 Longmont, CO 80501 P: 888-837-9959 P: 303-684-0135 x100 F: 303-485-5504 www.blackfox.com Training also available in English, Spanish, and Vietnamese</p>	<p>EPTAC Corporation 8025 So. Willow St. Longfellow Square, Bldg. II Manchester, NH 03103 P: 800-643-7822 P: 603-296-9850 F: 603-296-9853 www.eptac.com</p>	<p>Hong Kong Productivity Council HKPC Building, 3rd Floor 78 Tat Chee, Yau Yat Cheun Kowloon, Hong Kong P: +852 2 788 5678 F: +852 2 788 5405 sllaw@hkpc.org www.hkpc.org</p>
<p>HYTEK Sofievej 61 Postboks 519 DK-9100 Aalborg Denmark P: +45 9811 7003 F: +45 45 9633 2201 hytek@hytekaalborg.dk www.hytekaalborg.dk Training also available in Danish - Swedish - Norwegian</p>	<p>Microtek Laboratories 1435 Allec Street Anaheim, CA 92805 P: 714-999-1616 F: 714-999-1636 www.thetestlab.com</p>	<p>PIEK International Education Center (I.E.C.) B.V. Schelsberg 111 - 113 6413 AC HEERLEN The Netherlands P: +31 45 570 3333 F: +31 45 570 3320 info@piekiec.com www.piekiec.com Training also available in Dutch, German, English, French</p>	<p>Quality Technology Company 1320 Tower Road Schaumburg, IL 60173 P: 847-884-1900 F: 847- 884-7280 www.qtcom.com/ipc.html</p>
<p>Skaaning Quality & Certification SQC Engvej 3 DK-2960 Rungsted Kyst Denmark (P) +45 4586 3592 qualcert@qualcert.dk</p>	<p>Soldering Technology International 102 Tribble Drive Madison, AL 35758 P: 800-858-0604 P: 256-461-9191 F: 256-461-9566 www.solderingtech.com</p>	<p>The Surface Mount & Circuit Board Association Inc. PO Box 3140 MURRUMBEENA VIC 3163 Australia P: +61-3-9568 0599 F: +61-3-9568 0622 pollocka@smcba.asn.au www.smcba.asn.au</p>	<p>TCS 1213 Somerville Street Manchester, NH 03103 P: 800-955-4842 P: 603-626-8330 trainingct@aol.com</p>
<p>Trace Laboratories - Central 1150 West Euclid Avenue Palatine, IL 60067 P: 847-934-5300 F: 847-934-4600 www.tracelabs.com</p>	<p>Trace Laboratories - East Five North Park Drive Hunt Valley, MD 21030 P: 410-584-9099 F: 410-584-9117 www.tracelabs.com</p>		



ASSOCIATION CONNECTING
ELECTRONICS INDUSTRIES®

ANSI/IPC-T-50 Terms and Definitions for Interconnecting and Packaging Electronic Circuits Definition Submission/Approval Sheet

The purpose of this form is to keep current with terms routinely used in the industry and their definitions. Individuals or companies are invited to comment. Please complete this form and return to:

IPC
2215 Sanders Road
Northbrook, IL 60062-6135
Fax: 847 509.9798

SUBMITTOR INFORMATION:

Name: _____
Company: _____
City: _____
State/Zip: _____
Telephone: _____
Date: _____

- This is a **NEW** term and definition being submitted.
- This is an **ADDITION** to an existing term and definition(s).
- This is a **CHANGE** to an existing definition.

Term	Definition

If space not adequate, use reverse side or attach additional sheet(s).

Artwork: Not Applicable Required To be supplied

Included: Electronic File Name: _____

Document(s) to which this term applies: _____

Committees affected by this term: _____

Office Use	
IPC Office	Committee 2-30
Date Received: _____	Date of Initial Review: _____
Comments Collated: _____	Comment Resolution: _____
Returned for Action: _____	Committee Action: <input type="checkbox"/> Accepted <input type="checkbox"/> Rejected
Revision Inclusion: _____	<input type="checkbox"/> Accept Modify

IEC Classification

Classification Code • Serial Number

Terms and Definition Committee Final Approval Authorization:
Committee 2-30 has approved the above term for release in the next revision.
Name: _____ Committee: IPC 2-30 Date: _____

Technical Questions

The IPC staff will research your technical question and attempt to find an appropriate specification interpretation or technical response. Please send your technical query to the technical department via:

tel 847/509-9700

fax 847/509-9798

www.ipc.org

e-mail: answers@ipc.org

IPC World Wide Web Page www.ipc.org

Our home page provides access to information about upcoming events, publications and videos, membership, and industry activities and services. Visit soon and often.

IPC Technical Forums

IPC technical forums are opportunities to network on the Internet. It's the best way to get the help you need today! Over 2,500 people are already taking advantage of the excellent peer networking available through e-mail forums provided by IPC. Members use them to get timely, relevant answers to their technical questions. Contact KeachSasamori@ipc.org for details. Here are a few of the forums offered.

TechNet@ipc.org

TechNet forum is for discussion of issues related to printed circuit board design, assembly, manufacturing, comments or questions on IPC specifications, or other technical inquiries. IPC also uses TechNet to announce meetings, important technical issues, surveys, etc.

ComplianceNet@ipc.org

ComplianceNet forum covers environmental, safety and related regulations or issues.

DesignerCouncil@ipc.org

Designers Council forum covers information on upcoming IPC Designers Council activities as well as information, comments, and feedback on current designer issues, local chapter meetings, new chapters forming, and job opportunities. In addition, IPC can set up a mailing list for your individual Chapter so that your chapter can share information about upcoming meetings, events and issues related specifically to your chapter.

Gencam@ipc.org

Gencam deals with issues regarding the Gencam™ standards and specifications for Printed Circuit Board Layout and Design.

LeadFree@ipc.org

This forum acts as a peer interaction resource for staying on top of lead elimination activities worldwide and within IPC.

IPC_New_Releases@ipc.org

This is an announcement forum where subscribers can receive notice of new IPC publications, updates and standards.

ADMINISTERING YOUR SUBSCRIPTION STATUS:

All commands (such as subscribe and signoff) must be sent to listserv@ipc.org. Please DO NOT send any command to the mail list address, (i.e. <mail list>@ipc.org), as it would be distributed to all the subscribers.

Example for subscribing:

To: LISTSERV@IPC.ORG

Subject:

Message: subscribe TechNet Joseph H. Smith

Example for signing off:

To: LISTSERV@IPC.ORG

Subject:

Message: signoff DesignerCouncil

Please note you must send messages to the mail list address ONLY from the e-mail address to which you want to apply changes. In other words, if you want to sign off the mail list, you must send the signoff command from the address that you want removed from the mail list. Many participants find it helpful to signoff a list when travelling or on vacation and to resubscribe when back in the office.

How to post to a forum:

To send a message to all the people currently subscribed to the list, just send to <mail list>@ipc.org. Please note, use the mail list address that you want to reach in place of the <mail list> string in the above instructions.

Example:

To: TechNet@IPC.ORG

Subject: <your subject>

Message: <your message>

The associated e-mail message text will be distributed to everyone on the list, including the sender. Further information on how to access previous messages sent to the forums will be provided upon subscribing.

For more information, contact Keach Sasamori

tel 847/790-5315

fax 847/504-2315

e-mail: sasako@ipc.org

www.ipc.org/html/forum.htm

Education and Training

IPC conducts local educational workshops and national conferences to help you better understand conventional and emerging technologies. Members receive discounts on registration fees. Visit www.ipc.org to see what programs are coming to your area.

IPC Certification Programs

IPC provides world-class training and certification programs based on several widely-used IPC standards, including the IPC-A-610, the J-STD-001, and the IPC-A-600. IPC-sponsored certification gives your company a competitive advantage and your workforce valuable recognition.

For more information on programs, contact Alexandra Curtis
 tel 847/790-5377 fax 847/509-9798
 e-mail: curtal@ipc.org www.ipc.org

IPC Video Tapes and CD-ROMs

IPC video tapes and CD-ROMs can increase your industry know-how and on the job effectiveness. Members receive discounts on purchases.

For more information on IPC Video/CD Training, contact Mark Pritchard
 tel 505/758-7937 ext. 202 fax 505/758-7938
 e-mail: markp@ipcvideo.org www.ipc.org

IPC Printed Circuits Expo®



IPC Printed Circuits Expo is the largest trade exhibition in North America devoted to the PWB manufacturing industry. Over 90 technical presentations make up this superior technical conference. Visit www.ipcprintedcircuitexpo.org for upcoming dates and information.

Exhibitor information:

Contact: Mary MacKinnon
 Sales Manager
 tel 847/790-5386
 e-mail: MaryMacKinnon@ipc.org

Registration information:

Alicia Balonek
 Exhibits Manager
 tel 847/790-5398
 e-mail: AliciaBalonek@ipc.org

APEX® / IPC SMEMA Council Electronics Assembly Process Exhibition & Conference



APEX is the premier technical conference and exhibition dedicated entirely to the electronics assembly industry. Visit www.GoAPEX.org for upcoming dates and more information.

Exhibitor information:

Contact: Mary MacKinnon
 tel 847/790-5386
 e-mail: MaryMacKinnon@ipc.org

Registration information:

tel 847/790-5360
 fax 847/509-9798
 e-mail: goapex@ipc.org

How to Get Involved

The first step is to join IPC. An application for membership can be found in the back of this publication. Once you become a member, the opportunities to enhance your competitiveness are vast. Join a technical committee and learn from our industry's best while you help develop the standards for our industry. Participate in market research programs which forecast the future of our industry. Participate in Capitol Hill Day and lobby your Congressmen and Senators for better industry support. Pick from a wide variety of educational opportunities: workshops, tutorials, and conferences. More up-to-date details on IPC opportunities can be found on our web page: www.ipc.org.

For information on how to get involved, contact:

Jeanette Ferdman, Membership Director
 tel 847/790-5309 fax 847/509-9798
 e-mail: JeanetteFerdman@ipc.org www.ipc.org

Application for IPC Site Membership



Thank you for your decision to join IPC, Association Connecting Electronics Industries. IPC membership is site specific, which means that benefits of IPC membership are extended only to employees at the site that is designated on this application. To help IPC serve your member site in the most effective manner possible, please tell us what work is being done at your site by choosing the most appropriate member category. *(Check one box only.)*

INDEPENDENT PRINTED CIRCUIT BOARD MANUFACTURER

This facility manufactures, and sells to other companies, printed wiring boards (PWB's) or other electronic interconnection products on the merchant market.

What products do you make for sale?

One- and two-sided rigid, multilayer printed boards Flexible printed boards Other interconnections

Site General Manager _____
Name Title

EMSI COMPANY - Independent Electronics Assembly

This facility assembles printed wiring boards, on a contract basis, and may offer other electronic interconnection products for sale.

Site General Manager _____
Name Title

OEM - Original Equipment Manufacturer

This facility purchases and/or manufactures printed wiring boards or other interconnection products for use in a final product, which we manufacture and sell.

What is your company's primary product line?

Site General Manager _____
Name Title

INDUSTRY SUPPLIER

This facility supplies raw materials, machinery, equipment, or services used in the manufacture or assembly of electronic interconnection products.

What products or services does your company supply? (50 word limit, please)

The information that you provide here will appear in the next edition of the IPC Membership Directory.

Our company supplies:

GOVERNMENT AGENCY/ACADEMIC TECHNICAL LIAISON

This government agency or accredited university, college or technical training school is directly concerned with design, research and utilization of electronic interconnection devices. (Must be a non-profit or not-for-profit organization.)

Application for IPC Site Membership



Site Information: (Please print or type)

Company Name			
Street Address			
City	State	Zip/Postal Code	Country
Main Switchboard Phone No	Main Fax No.		
Company E-Mail Address	Website URL		
Name of Primary Contact for all IPC matters	Title	Mail Stop	
Phone No.	Fax No	E-Mail	
Name of Senior Management Contact:	Title:	Mail Stop	
Phone No	Fax No	E-Mail	

Please attach business card of primary contact here.

Please designate your site's Technical Representatives:

For PWB/PWA design-related information and activities:

Contact Name	Title	Phone	Fax	E-mail
--------------	-------	-------	-----	--------

For PCB fabrication-related information and activities:

Contact Name	Title	Phone	Fax	E-mail
--------------	-------	-------	-----	--------

For Electronics Assembly-related information and activities:

Contact Name	Title	Phone	Fax	E-mail
--------------	-------	-------	-----	--------

Please designate your site's Management Representatives:

For PWB/PWA design-related information and activities:

Contact Name	Title	Phone	Fax	E-mail
--------------	-------	-------	-----	--------

For PCB fabrication-related information and activities:

Contact Name	Title	Phone	Fax	E-mail
--------------	-------	-------	-----	--------

For Electronics Assembly-related information and activities:

Contact Name	Title	Phone	Fax	E-mail
--------------	-------	-------	-----	--------

Application for IPC Site Membership



MEMBERSHIP DUES SCHEDULE

Please check one:

- \$1,000.00** – Annual dues for Primary Site Membership
Twelve months of IPC membership begins from the time the application and payment are received at the IPC office.
- \$800.00** – Annual dues for Additional Facility Membership
An additional membership for a site within an organization where there already is a current Primary Site IPC membership.
- \$600.00**** – Annual dues for an independent PCB/PWA fabricator or independent EMSI provider with annual sales of less than \$1,000,000.00. USD
** Please provide proof of annual sales.
- \$250.00** – Annual dues for Government Agency or Academic Technical Liaison Membership. Must be not-for-profit organization.

TMRC MEMBERSHIP

- Please send information on participation in the Technology Market Research Council (TMRC) program. Only current IPC member sites are eligible to participate in this **calendar year** program, which is available for an additional fee.
- Yes, sign up our site now:**
 - \$950.00** - Primary TMRC member site
 - \$400.00** - Additional facility TMRC member. Another site within our organization is already a TMRC program participant.

Name of Primary Contact for all TMRC matters:

Phone _____

Fax _____

E-Mail _____

PAYMENT INFORMATION

Enclosed is our check/money order for \$ _____

Mail application with check or money order to:

IPC
Dept. 77-3491
Chicago, IL 60678-3491

Fax or mail application with credit card payment to:

IPC
*2215 Sanders Road
Northbrook, IL 60062-6135
Tel: 847-509-9700
Fax: 847-509-9798

** Overnight deliveries to this address only*

Please bill my credit card (circle one) for \$ _____

- MasterCard American Express Visa Diners Club

Account No _____

Expiration Date _____

Name of Card Holder _____

Authorized Signature _____

Phone Number _____

QUESTIONS ?

Call the IPC Member Services Department in Northbrook, Illinois,
at: 847-509-9700 (extensions 5309/5372)
or fax us at 847.509-9798

E-mail: JeanetteFerdman@ipc.org SusanStorck@ipc.org

Application for IPC Site Membership



INFORMATION DISTRIBUTION

IPC has significant member benefits available to a wide range of individuals within your organization. To ensure that your facility takes advantage of these benefits, please provide the name of the individual responsible for each of the functional areas listed below. If one person has multiple responsibilities, please list that person's name as many times as necessary.

Chief Executive:

Name	Title/Mail Stop	Phone	Fax	E-mail
------	-----------------	-------	-----	--------

Sales/Marketing:

Name	Title/Mail Stop	Phone	Fax	E-mail
------	-----------------	-------	-----	--------

Finance (CFO)

Name	Title/Mail Stop	Phone	Fax	E-mail
------	-----------------	-------	-----	--------

Human Resources

Name	Title/Mail Stop	Phone	Fax	E-mail
------	-----------------	-------	-----	--------

Environmental/Safety

Name	Title/Mail Stop	Phone	Fax	E-mail
------	-----------------	-------	-----	--------

Design/Artwork

Name	Title/Mail Stop	Phone	Fax	E-mail
------	-----------------	-------	-----	--------

Product Assurance

Name	Title/Mail Stop	Phone	Fax	E-mail
------	-----------------	-------	-----	--------

Manufacturing

Name	Title/Mail Stop	Phone	Fax	E-mail
------	-----------------	-------	-----	--------

Training

Name	Title/Mail Stop	Phone	Fax	E-mail
------	-----------------	-------	-----	--------

Purchasing

Name	Title/Mail Stop	Phone	Fax	E-mail
------	-----------------	-------	-----	--------

IPC REVIEW SUBSCRIPTION LIST

One of the many benefits of IPC membership is a subscription to the *IPC Review*, our monthly magazine. Please list below the names of individuals who would benefit from receiving our magazine, which provides information about the industry, IPC news, and other items of interest. A subscription for the IPC Primary Contact person is entered automatically.

Name	Title/Mail Stop
------	-----------------

Name	Title/Mail Stop
------	-----------------

Name	Title/Mail Stop
------	-----------------

Name	Title/Mail Stop
------	-----------------

Name	Title/Mail Stop
------	-----------------

Name	Title/Mail Stop
------	-----------------



ASSOCIATION CONNECTING
ELECTRONICS INDUSTRIES

Standard Improvement Form

IPC-A-600G

The purpose of this form is to provide the Technical Committee of IPC with input from the industry regarding usage of the subject standard.

Individuals or companies are invited to submit comments to IPC. All comments will be collected and dispersed to the appropriate committee(s).

If you can provide input, please complete this form and return to:

IPC
2215 Sanders Road
Northbrook, IL 60062-6135
Fax 847 509.9798

1. I recommend changes to the following:

Requirement, paragraph number _____
 Test Method number _____, paragraph number _____

The referenced paragraph number has proven to be:

Unclear Too Rigid In Error
 Other _____

2. Recommendations for correction:

3. Other suggestions for document improvement:

Submitted by:

Name

Telephone

Company

E-mail

Address

City/State/Zip

Date



ASSOCIATION CONNECTING
ELECTRONICS INDUSTRIES

ISBN #1-580987-40-0

2215 Sanders Road, Northbrook, IL 60062-6135
Tel. 847.509.9700 Fax 847.509.9798
www.ipc.org